

TROLEXK



AIR XKD

USER MANUAL

1	General description	6
1.1	Main features.....	6
1.2	Performance data.....	7
1.3	Intended use.....	7
1.4	Limits of use.....	7
2	Product safety	8
3	Danger from process	9
4	Safety procedures	10
4.1	Laser safety precautions.....	10
5	System components	12
5.1	TX8005 Air XD Dust Monitor.....	13
5.2	Particulate flow path.....	14
5.3	Peripherals and accessories.....	15
6	Certification	17
6.1	Compliance.....	17
7	Technical information	18
7.1	Product specification.....	18
7.2	Product dimensions.....	20
8	Hardware installation	21
8.1	Safety precautions.....	21
8.2	Mounting details.....	22
8.3	Main parts.....	23
8.4	Electrical connections.....	24
8.5	I/O terminals.....	26
8.6	Power connections.....	27
8.7	RS485 – output signals.....	29
8.8	RS485 – line connections.....	29
9	Commissioning	30
9.1	First power on.....	30
9.2	Breathe software.....	30

10	Controls and indicators	31
10.1	Navigation	31
10.2	Main function keys	32
10.3	Shortcut navigation	34
11	General operation	35
11.1	User interface display	35
11.2	PM value display map	35
11.3	Top cap closed	36
11.4	Settings structure	37
11.5	Passcode protection	38
11.6	Change passcode	39
11.7	“Enable”/“Disable” passcode protection	39
11.8	PM settings	39
11.9	Setting custom PM values	40
11.10	PM density	41
11.11	Averaging settings	41
11.12	Alarm settings	41
11.13	Channel select	42
11.14	Threshold channel	43
11.15	Set alarm threshold	43
11.16	Alarm latching	43
11.17	“Enable”/“Disable”	44
11.18	4 - 20 mA outputs	44
11.19	Select PM channel	45
11.20	Map 4 - 20 mA	45
11.21	Set maximum PM value	45
11.22	“Enable”/“Disable”	46
11.23	Status	46
11.24	Communications	46
11.25	Ethernet communications	46

11.26	Network status.....	47
11.27	IP settings.....	47
11.28	Ethernet operating mode.....	47
11.29	Ethernet connection status.....	48
11.30	RS485 MODBUS communications.....	48
11.31	Set baud rate.....	48
11.32	Set device address.....	49
11.33	Set communications parity.....	49
11.34	Display.....	49
11.35	Adjusting display contrast.....	49
11.36	Set display backlight.....	50
11.37	Set display colour.....	50
11.38	Set display sleep.....	50
11.39	Date and time.....	51
11.40	Set date.....	51
11.41	Set time.....	51
11.42	System.....	51
11.43	System information.....	52
11.44	Restart controller.....	52
11.45	Data download.....	52
11.46	Memory module.....	53
11.47	Firmware update.....	54
11.48	Relay override.....	55
11.49	Watchdog.....	55
12	Instrument configuration.....	56
12.1	Default settings.....	56
12.2	On-site configuration.....	56
12.3	MODBUS addresses.....	56
12.4	Reading floating point registers.....	58
12.5	Coil register.....	59

12.6	Holding register.....	61
12.7	Instrument self-test.....	62
13	Updating firmware.....	64
13.1	Units with controller v 1.2.3 or earlier and/or memory module v1.4 or earlier.....	64
13.2	Preparation.....	64
13.3	Steps to update controller.....	65
13.4	Steps to update memory module.....	65
14	Maintenance.....	67
14.1	Visual checks.....	67
14.2	Cleaning labels.....	67
14.3	Air entry/exit apertures.....	67
14.4	Filter replacement.....	67
14.5	Preventative maintenance.....	68
14.6	Sensor cleaning.....	68
14.7	Compliance audit check.....	69
14.8	Compliance audit check – results.....	71
15	Troubleshooting.....	73
15.1	High temperature start-up.....	73
15.2	Low temperature start-up.....	73
15.3	Fault codes.....	73
16	Glossary and definitions.....	75
17	Disposal.....	76
18	Get in touch.....	77
18.1	Technical support.....	77
18.2	Feedback.....	77
	Disclaimer.....	78
	Trademark.....	78

The Trolex Air XD particulate monitor is designed to provide detailed, accurate, real-time data on airborne particulates so that users can take appropriate actions to stay safe and ensure personnel are fully protected from particulate-related health hazards. The Air XD allows users to simultaneously monitor multiple Particulate Matter (PM) sizes (PM1.0, PM2.5, PM4.25, PM10, as well as custom sizes) and can report on Total Suspended Particulates (TSP). Precise data is collected for measurable particulates, enabling detailed size profiling and analysis using the application software.

The Air XD uses an innovative optical particle counter (OPC) that combines adaptive particle flowrate with advanced sensing technology to ensure a high level of measurement accuracy. The size of each particle is instantaneously measured and classified at up to 10,000 samples per second to allow detailed real-time reporting in high dust environments.

As the Air XD records data on all particulates between 0.35 μm and 40 μm , users can easily access and view detailed information about a wide range of PM sizes. Measurement information can be viewed via the instrument display or as live or historical readings using the application software.



TX8005 Air XD Dust Monitor

1.1 Main features

- Real-time, continuous measurement of atmospheric dust concentration
- High-reliability, low-maintenance for high dust environments
- High capacity OPC
- Industry standard sizing PM1.0, PM2.5, PM.4.25 and PM10

- Low-end resolution measuring down to 0.35 μm with 99.9% capture
- Ability to display TSP measurement reading
- Quantification of particle size categories to customer requirements (custom sizing)
- Operational stability in varying environment and atmospheric conditions
- On-device display readout
- Choice of display modes: 'Live' readout or configurable 'Averages'
- Two configurable relay output contacts for remote alarms and control functions
- Two 4 - 20 mA analogue output signals of measured averages
- Remote RS485 MODBUS RTU Serial I/O interface
- Ethernet MODBUS TCP/IP output
- High visibility warning indicators
- 'Plug and play' installation

1.2 Performance data

Using current advancements in light-scattering techniques combined with patented data processing algorithms, the Air XD is able to achieve levels of accuracy ($\pm 5\%$) normally only found in high-end laboratory instruments.

1.3 Intended use

The Air XD is a particulate monitor designed for use in range of applications and environments. The instrument is suitable for monitoring in either indoor or outdoor ambient air conditions and can cope with both high and low particulate concentration levels (up to $1,500 \text{ mg/m}^3$). The instrument is designed to be low maintenance and does not use pumps or filters. The sensing element has an adaptive flowrate to increase accuracy in environments with varying airflow.

1.4 Limits of use

To ensure the optimum performance and safe operation, the Air XD must be operated as per the limits detailed in the technical data section of this user manual. Operation outside these limits may result in damage to the equipment or failure to achieve the performance specification.

Continual operation of the Air XD at extremes of the specified temperature limits may reduce the operating lifetime of the product.

Troxex will not be liable for any injury or damage caused by incorrect installation, setup, operation or maintenance resulting in a failure to follow the procedures and safety instructions provided in this user manual.

The following symbols are used in this manual or on the instrument to indicate procedures that if not followed correctly, may result in personal injury or damage to equipment.



WARNING!

Alerts the user to a potentially hazardous procedure or practice which if not followed correctly, can result in serious personal injury or injury of others.



CAUTION!

Alerts the user to a procedure or practice which if not followed correctly, can result in damage to the system or ancillary equipment.



WARNING! – ELECTRIC SHOCK RISK

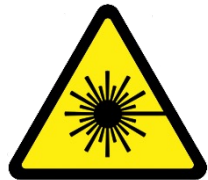

WARNING! – LASER RADIATION

The use of controls, adjustments, or procedures other than those specified in this user manual may result in exposure to hazardous optical radiation.

3. DANGER FROM PROCESS

It is possible that the Air XD could be installed in environments that contain process particulates which can be hazardous to health.

Unless process conditions are known to be entirely safe, suitable precautions such as the use of breathing apparatus or environmental purging/detoxification should be employed before entry is made into the installation or maintenance environment.

Note: This product variant is not designed for use with flammable or explosive dust in combustible concentrations. In the event of potential combustible concentrations becoming present in a non-hazardous location, this variant of the Air XD must be powered down.

It is the responsibility of the installer to risk assess the suitability of the instrument for installation and use in the intended application.

Always observe the safety precautions detailed in this user manual. Personnel installing and maintaining the equipment are responsible for their personal safety and correct handling of the equipment in accordance with all safety instructions detailed.

Follow all warnings and instructions marked on the instrument. Warning on the instrument indicate a hazard at or near the location of the warning label.

Installation in working environments can be challenging and correct setup is critical to the function of the instrument. It is important that you carefully read the entire user manual before using and installing the Air XD for the first time.

Peripheral components such as the power supply and communications module/peripheral or interface must be installed according to the manufacturer's instructions and the installation location's prevailing statutory regulations.

The installation of the instrument must only be carried out by competent personnel. Each installation needs to be considered with reference to the local safety regulations and authorities.

Refer to the '**Certification and Conformity**' section of this user manual and to the relevant certificates for any installation parameters and special conditions of safe use.

Observe the national safety regulations issued, for example, by the employers' liability insurance association, social security institutions, occupational safety and health authorities or other safety organisations.

4.1 Laser safety precautions

The Air XD is rated via the *Class 1* 'Laser Safety Guideline' under all conditions of normal use.

Class 1 laser products may contain laser systems of a higher class but there are adequate engineering control measures to ensure that access to the beam is not permitted during normal use.



WARNING – *Class 3B* laser radiation: **do not** open the laser housing when the laser is powered on as it may result in eye damage from directly viewing the laser beam.

The Air XD complies with:

- IEC 60825-1 2014
 - 21 CFR-1040.10 and 1040.11
-

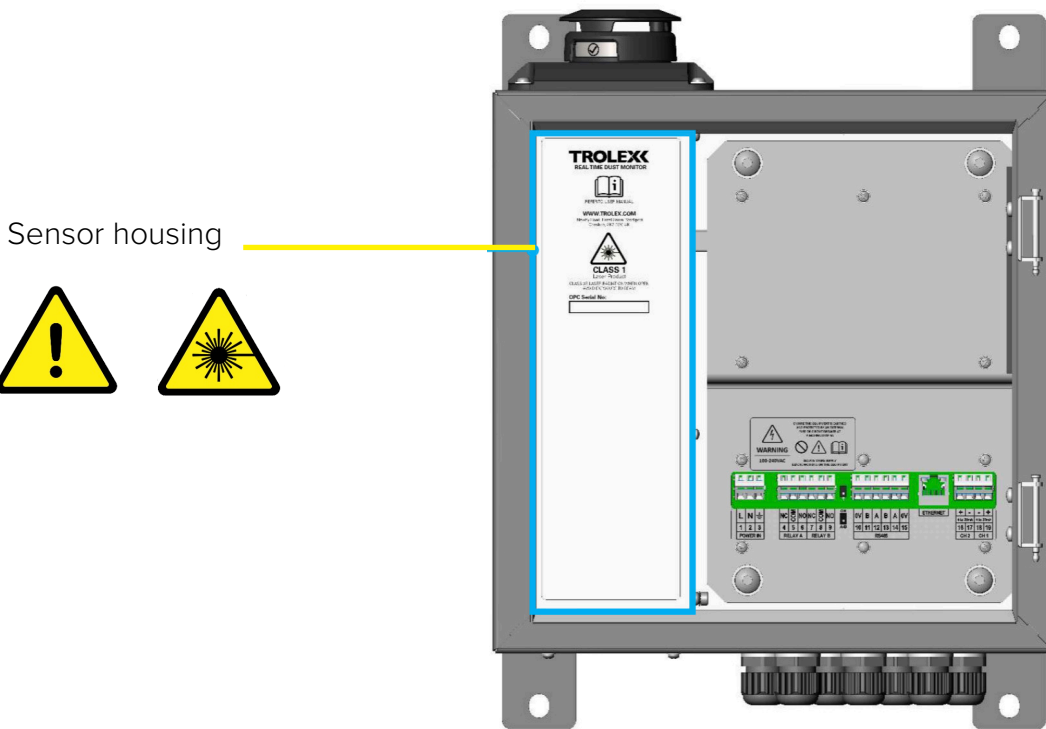

WARNING – There are no user-serviceable parts inside the Air XD sensor housing. Servicing should only be carried out by Trolex or an approved service technician.

5. SYSTEM COMPONENTS

The Air XD is typically installed as a stand-alone instrument for general purpose applications. The instrument is supplied with peripherals fitted to allow for the plug and play installation to universal mains power supplies and data outputs.

The Air XD instrument and supporting Trolex [Breathe](#) software is specifically designed to work in conjunction with each other using proprietary protocols and design features. The system also supports third-party power supplies and communication protocols where required.



Example installation configuration

Note: M20 gland entries are provided for custom installation requirements. Gland entries may be blanked, and installations may vary from diagram shown.

5.1 TX8005 Air XD Dust Monitor

The Air XD Dust Monitor uses an OPC that is located inside a robust stainless steel housing. This provides isolation and ingress protection between the particle flow path and the main control circuits. Control circuits are housed in a lockable, IP66-rated coated steel enclosure. Information and settings can be accessed using the keypad and display located on the front of the instrument.

The Air XD can be configured to report on PM size concentrations or TSP based on user requirement, with the option of two configurable setpoint relay outputs. Detailed information can be transmitted via an RS485 or ethernet connection to a computer running the Trolex [Breathe](#) software or downloaded directly from the internal memory module using a USB storage device.

The figure below shows the location of the navigation buttons, display screen and status LEDs. Power and network connections enter the main housing via cable entry glands located on the bottom of the instrument. The Air XD can be wall or stand mounted via mounting brackets.

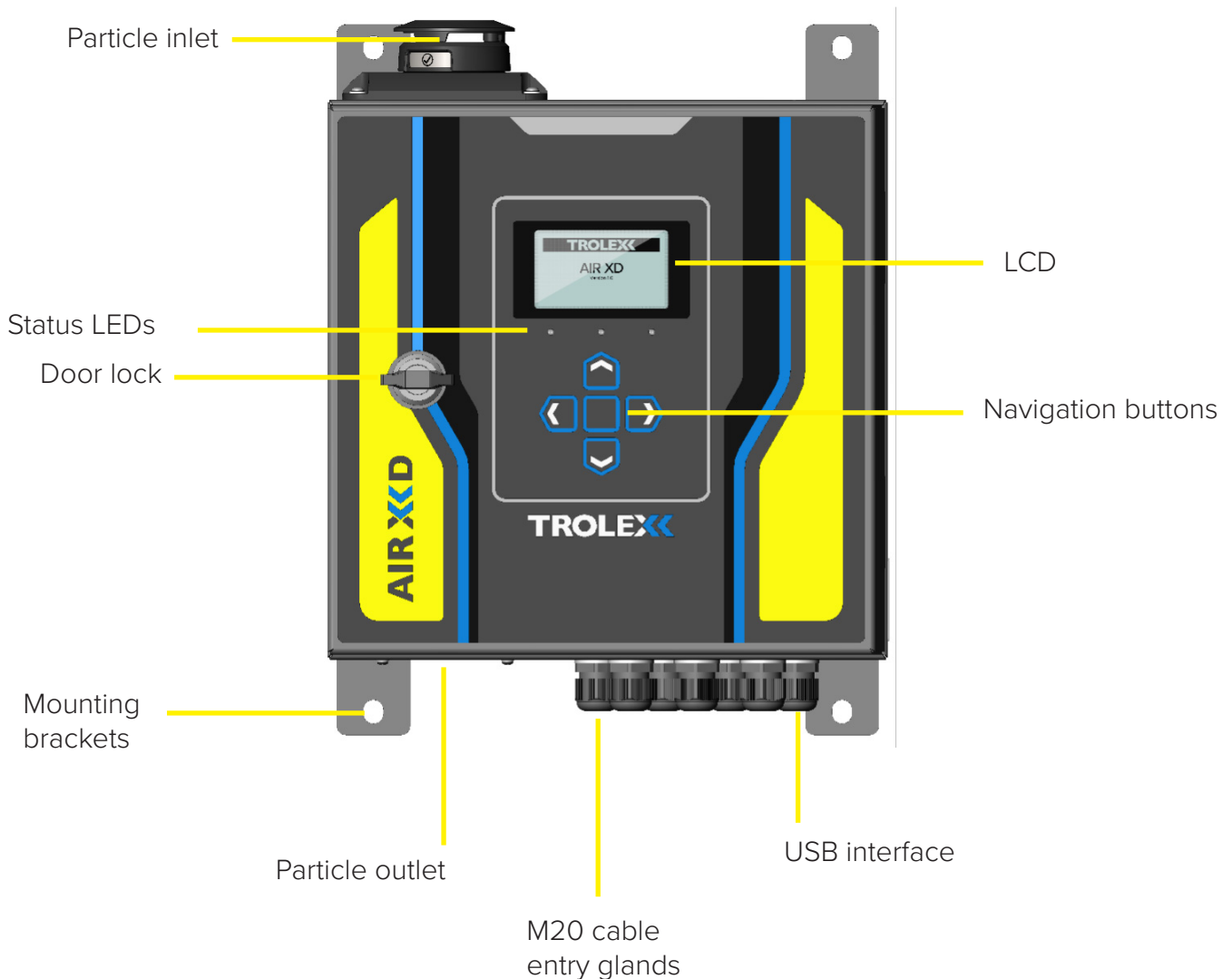

5.2 Particle flow path

The Air XD has been designed with the ability to restrict ingress through the particulate flow path during routine maintenance and cleaning periods. A rotational top cap is used to ‘open’ or ‘close’ the particle flow path to provide increased ingress protection during cleaning.

It is recommended that the top cap is set to the ‘closed’ position during instrument maintenance and cleaning to ensure the dust sensor is not exposed to unnecessary ingress. When the top cap is rotated into the ‘closed’ position, the Air XD conforms to IPX6.

The Air XD can detect whether the flow path is ‘open’ or ‘closed’ and will record top cap positions to aid with instrument maintenance schedules.

Note: Rotate the top cap to move between ‘open’ and ‘closed’ positions.

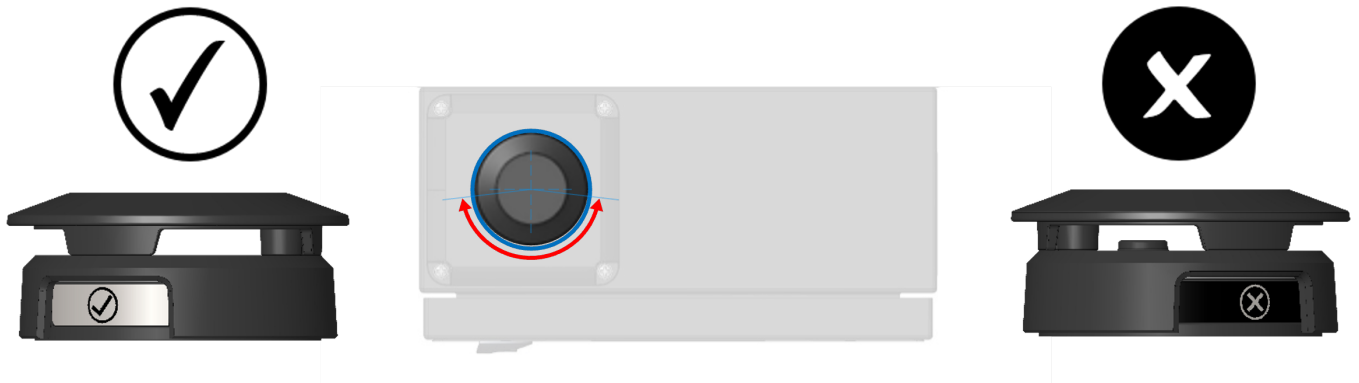

‘Open’ flow path.



‘Closed’ flow path.

5.3 Peripherals and accessories

Power supply

The Air XD can be ordered and configured to allow connection to a standard 100 to 240 V ac power supply **or** a 9 to 36 V dc power supply. Before connecting a power supply to the instrument, ensure that the supply source is compatible with the instrument and information outlined on the appropriate rating plate. See below for rating plate details:

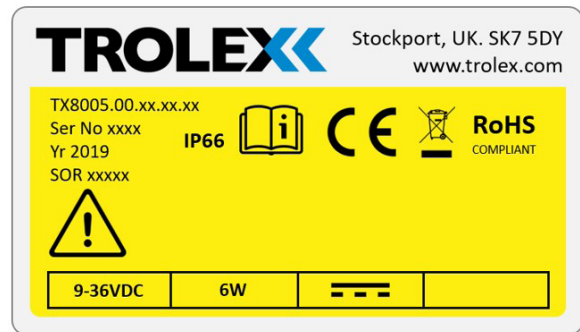
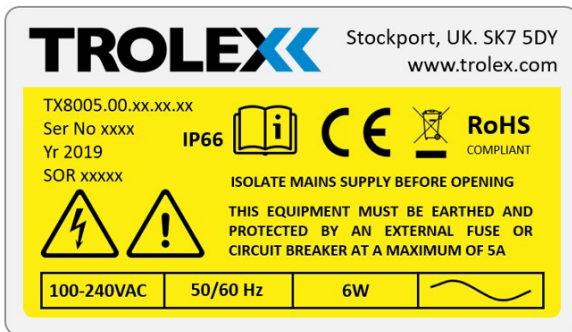

Windows PC or server

A Windows PC or server is required to run the Trolex **Breathe** software (required to collect and process data from the Air XD instrument).

It is recommended that client computers meet or exceed the following system requirements, before installing the Trolex **Breathe** software. This applies to both dedicated hardware and virtual machines. Other configurations may work but cannot be guaranteed.

CPU	Intel® Core™ i5-6300U CPU @ 2.4 GHz
RAM	8 GB (minimum)
Disc space*	20 GB (recommended)
Communications	DB9 serial port, USB serial port, and ethernet port
Operating system	Windows 10

*This is dependent on the data capture.

Troxel **Breathe** software

Data transmitted to a PC or server is collected, stored, and processed using the supporting Troxel **Breathe** software. The instrument communicates with the **Breathe** software using MODBUS RTU (RS485).

Information collected by the Air XD device can also be locally downloaded via USB, and imported into the software for data analysis and interrogation.

Breathe application software can be used to monitor in real time or review historical data. It allows the user to monitor instrument information, graph live data sets and monitor alarms.

Note: Operating instructions for the application software are provided in a separate user manual.



6.1 Compliance

The Air XD complies with the following European Union directives:



Electromagnetic Compatibility (EMC) Directive
2014/30/EU

Low Voltage Directive (LVD) 2014/35/EU

- **EN 61326-1:2013**
- **EN 61000-6-2:2019**
- **EN 61000-6-3:2007+A1:2011**

Low Voltage Directive (LVD) 2014/35/EU

- **EN 61010-1:2010**
-

RoHS
COMPLIANT

Restriction of Hazardous Substances (RoHS)
Directive 2011/65/EU

7.1 Product specification

Particulate sensing parameters

PM size range	PM1.0, PM2.5, PM4.25, PM10 TSP
TSP range	Up to 40 μm displayed in mg/m^3 or $\mu\text{g}/\text{m}^3$
Extended range	TSP indicative up to 150 μg displayed in mg/m^3 or $\mu\text{g}/\text{m}^3$
PM measurement range	0.35 to 40 μm over 24 bins
PM measurement capability*	Up to 1,500 mg/m^3
PM continuous operating range**	Up to 25 mg/m^3
PM density	0.8 g/ml - 8.0 g/ml (default: 1.65 g/ml)
PM measurement units	mg/m^3 or $\mu\text{g}/\text{m}^3$
Averaging period	1 second to 24 hours
Averaging channels	~ 1.5 L/m (nominal)
Sampling interval	$\pm 25\%$
Particle count	Up to 10,000 (particles/second)
Flow rate	Dynamic (1.2 L.min nominal)
Total flow rate	5.5 L/min (typical)
Accuracy	$\pm 5\%$

*The instrument can define particulate measurement peak trends up to the quantity specified.

**During sustained high dust loading periods, the instrument will report on PM data up to the quantity specified.

Note: Sustained exposure to PM quantities above 25 mg/m^3 will be logged; however, this may affect the operating life of the OPC.

Technical specification

Ambient temperature limits	-10 to 45 °C
Humidity	0 to 95% RH (non-condensing)
Protection classification	Main enclosure, dust and waterproof: IP66 Particulate flow path (cap open): IP22 Particulate flow path (cap closed): IPX6
Housing material	Polymer coated stainless steel
Net weight	8.2 kg
Cable entries	5 x M20 with removable blanks 1 x M20 breather gland (where specified) 1 x M20 USB connector (where specified)
Power	100 V to 240 V ac 50/60 Hz 9 to 36 V dc
Supply current	100 mA nominal ac variant 660 mA nominal dc variant
Power consumption	6 W
Inrush current	350 mA peak
Relay outputs	Two configurable (alarm outputs) Dry contact Maximum rating 36 V ac/dc 300 mA (internal overcurrent and overvoltage protection fitted)
4 - 20 mA outputs	Two configurable (real time or average readings) R1 and R2 with adjustable setpoints Maximum attached load: 280 Ω
Communications	RS485 data output with MODBUS RTU protocol Ethernet (MODBUS TCP/IP optional)
Data download	External USB interface
Instrument data storage	8 GB > 10 years (log rate dependent) Stored device data can be cleared as required
User interface	128 x 64 dot matrix display with RGB backlight
Visual alarms	Display RGB backlight
Indicators	1 x green high brightness LED – sensor heartbeat 1 x blue high brightness LED – communications

7.2 Product dimensions

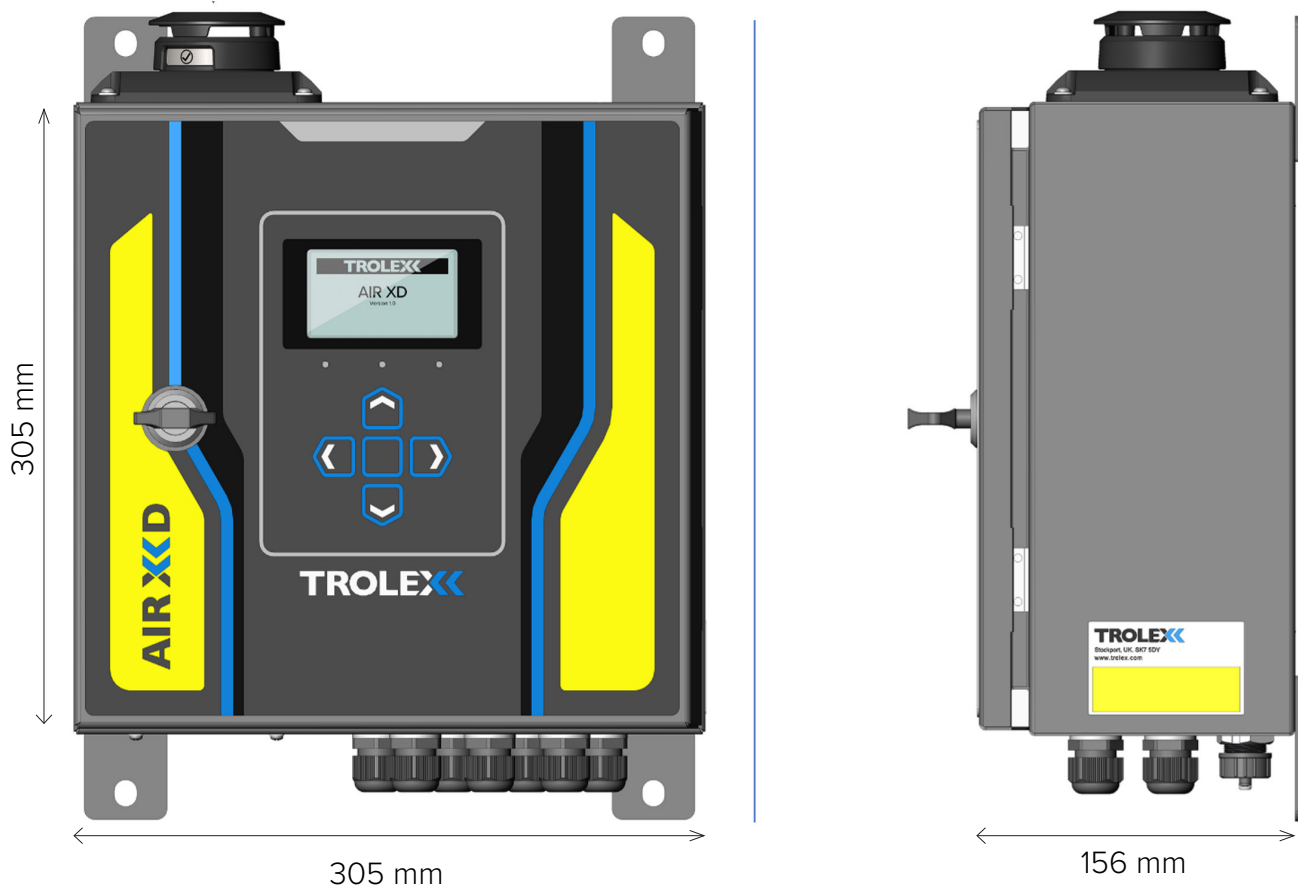

Note: Recommended 100 mm inlet clearance.

8.1 Safety precautions

Refer to **section 4** of this user manual before undertaking the installation of the Air XD instrument. The installation location of the Air XD instrument is the responsibility of the installer and care should be taken to ensure an appropriate position has been selected. Consider the location of a suitable power supply and external fuses, access to a communications network and the protection of cabling from damage.

1. Secure the Air XD to a suitable mounting surface using the integrated mounting brackets.
2. Ensure that the Air XD is mounted in an upright position.
3. Unlock and open the enclosure door.
4. Ensure that power is isolated before making electrical connections to the instrument.
5. Power supply voltage and frequency must match the instrument (refer to rating plate).
6. Ensure external switches or fuses are installed where applicable.
7. Run the required cables through the cable glands provided at the base of the enclosure.
8. Wire the cables into the relevant terminals as indicated on the internal plate (refer to **section 8.4**).
9. Tighten the cable gland against the cable to ensure an IP seal.
10. Close and lock the door after use to maintain the IP rating of the enclosure.
11. Ensure that the air entry and exit ports are not restricted or covered.

Note: When the door is open, care must be taken to ensure minimal internal contamination during installation.

8.2 Mounting details

Note: Ensure the Air XD is mounted **vertically** during installation.

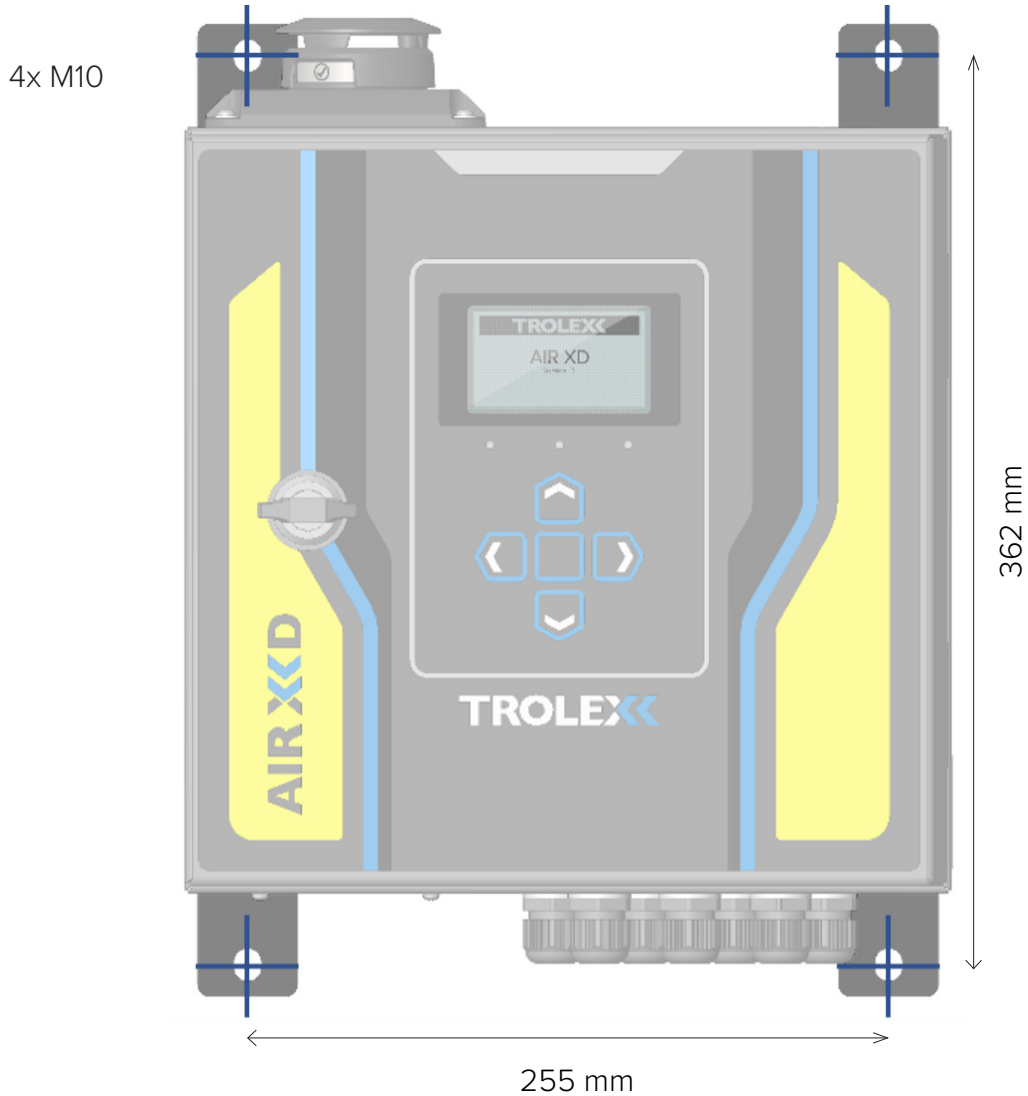

The figure and tables below detail the connections available internally in the Air XD. The connections can be accessed by opening the front housing of the instrument using the supplied key.

8.3 Main parts

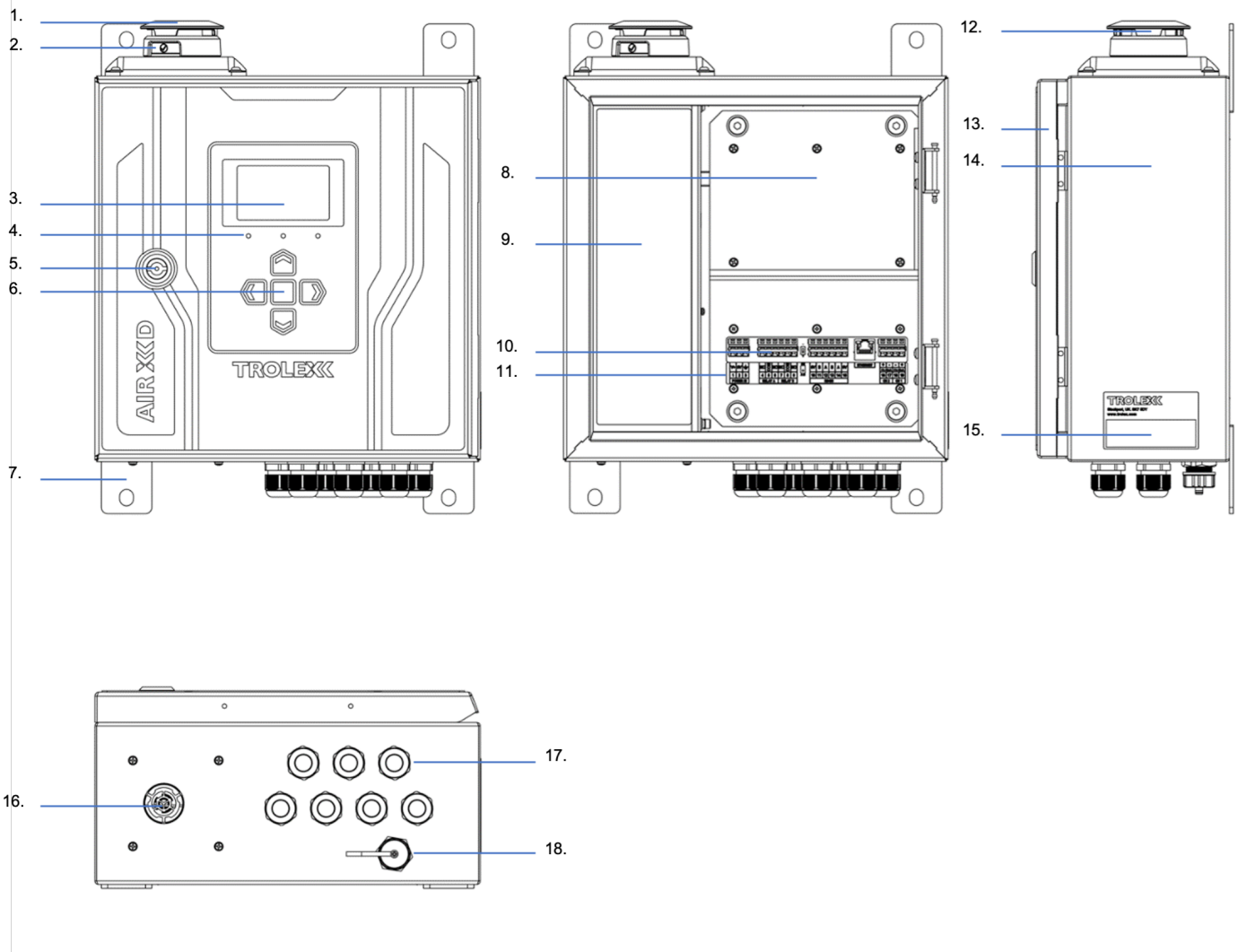

- 1. Ingress cap
- 2. Inlet flow 'on'/'off' label
- 3. Display
- 4. Status LEDs
- 5. Door lock
- 6. Navigation keypad
- 7. Mounting brackets
- 8. PCB mounting plate
- 9. Particulate sensor housing
- 10. Input/output terminals
- 11. Input/output labels
- 12. Air inlet aperture
- 13. Enclosure door
- 14. Main enclosure
- 15. Rating plate
- 16. Air outlet grille
- 17. M20 cable glands
- 18. USB interface

8.4 Electrical connections

The connections can be accessed by opening the front housing of the instrument using the supplied key.

The connections are clearly labelled on the internal metal plate. Wires are inserted into the connector terminals by first using a small flat-head screwdriver or dedicated tool inserted into the small recess above the appropriate terminal. Pushing the screwdriver down into the mechanism opens the connector terminal allowing the wire to be inserted into the opening.

Before placing the wire into the connector, the wire must be stripped and crimped to ensure a good electrical connection. Once the wire has been sufficiently pushed into the terminal, remove the screwdriver to allow the mechanism to clamp the crimped end.

Give a gentle tug on the wire to make sure it has been clamped sufficiently by the connector.

Ensure mains cables are fixed in place using the mounting points provided. Details of the connections are given in **Table 1** and **Table 2** below.

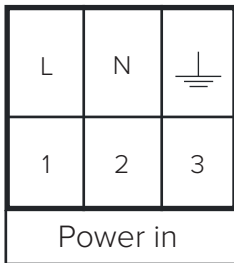
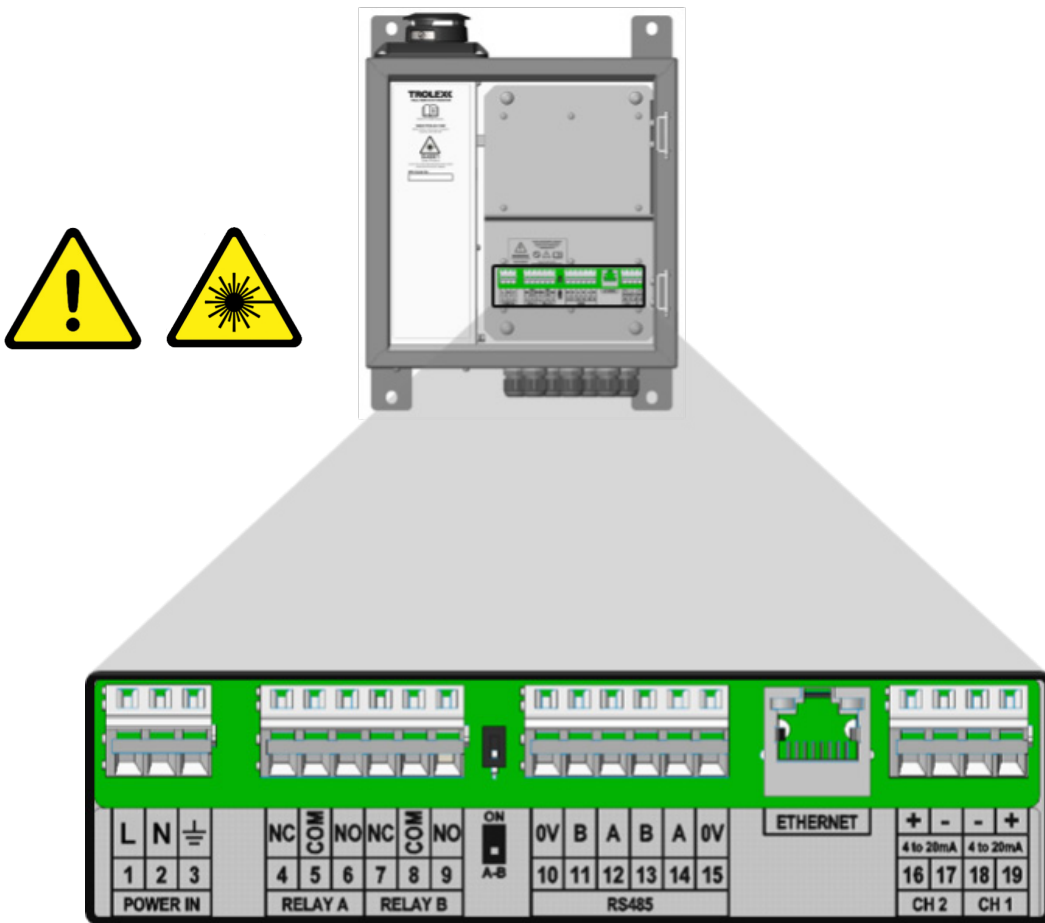

ac power input.

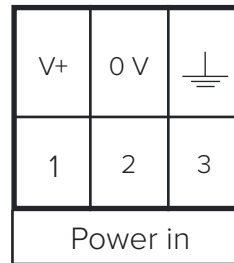

dc power input.

ac power in		dc power in		Outputs			
1	Supply voltage	4	Supply voltage	7	RS485/USB switch	11	V out
2	0 V return	5	0 V return	8	RS485 B	12	0 V
3	Earth	6	Earth	9	RS485 A	13	V out
				10	RS485 0 V	14	V out
						15	USB
						16	Ethernet

Table 1: Power, relay and RS485 terminal connections.

The pin connections listed in **Table 2** for the Ethernet connector are not labelled in the figure but relate to the internal connections of the RJ45 connector with 'Pin 1' on the left up to 'Pin 8' on the right.

The switches shown either side of the RS485 terminals in the figure allow setting of half duplex or full duplex mode.

Ethernet	4 - 20 mA – Ch2 and Ch1	
Pin 1: TX+	16	Supply voltage
Pin 2: TX-	17	0 V return
Pin 3: RX+	18	0 V return
Pin 4: No connection	19	+ out
Pin 5: No connection		
Pin 6: RX-		
Pin 7: No connection		
Pin 8: No connection		

Table 2: Ethernet and 4 - 20 mA connections.

8.5 I/O terminals

Power, RS485, 4 - 20 mA and relay connection terminal data is highlighted below.

Actuation type	Operating tool
Solid/stranded conductor	0.08 to 2.5 mm ² / 28 to 12 AWG
Conductor with ferrule	0.25 to 1.5 mm ²
Strip length	5 to 6 mm / 0.2 to 0.24 in

8.6 Power connections

For instruments connected to an **ac power supply**, it is the responsibility of the installer to ensure that the instrument is installed with the following protection:

- An external fuse or circuit breaker at a maximum of 5 A.
- Externally earthed.

See label below for details.

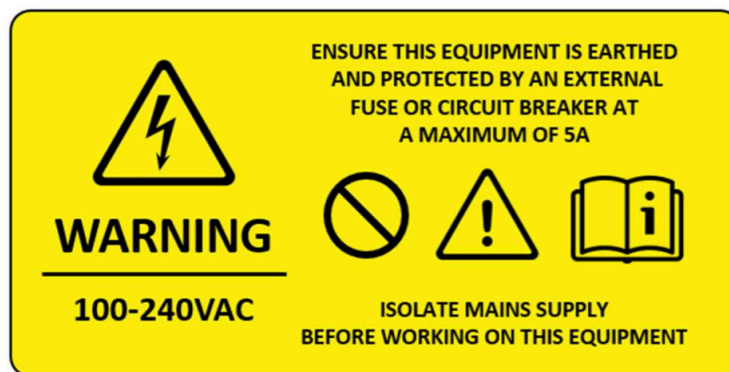

For instruments connected to a **dc power supply**, it is the responsibility of the installer to ensure that the instrument is installed with a dc supply, meeting re-enforced insulation requirements of **EN61010-1** or equivalent.

For instruments connected to an **ac power supply**, ensure that the equipment is protected by an external fuse or circuit breaker at a maximum of 5 A.

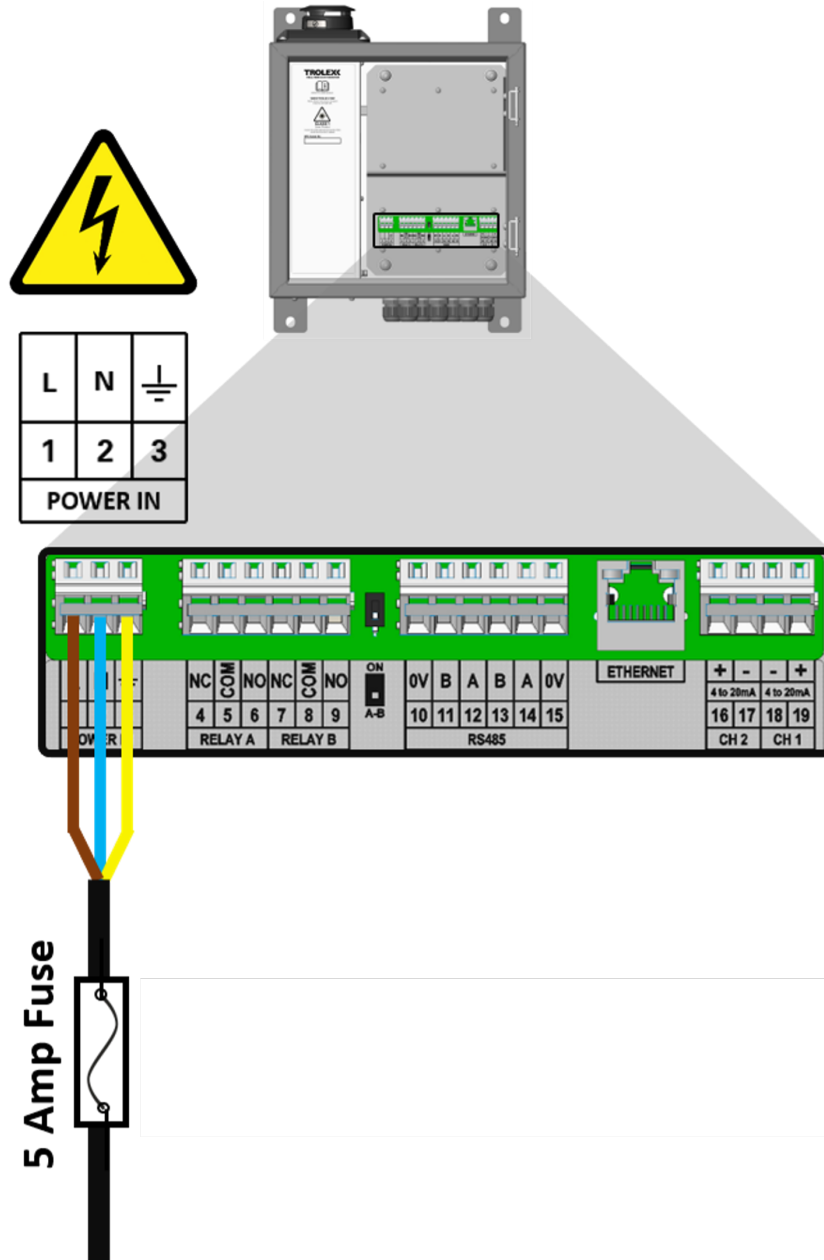

8.7 RS485 – output signals

The Air XD provides in and out RS485 terminals to allow ‘daisy-chaining’ of multiple MODBUS devices.

For example: ‘Pin 11’ is common with ‘Pin 13’.

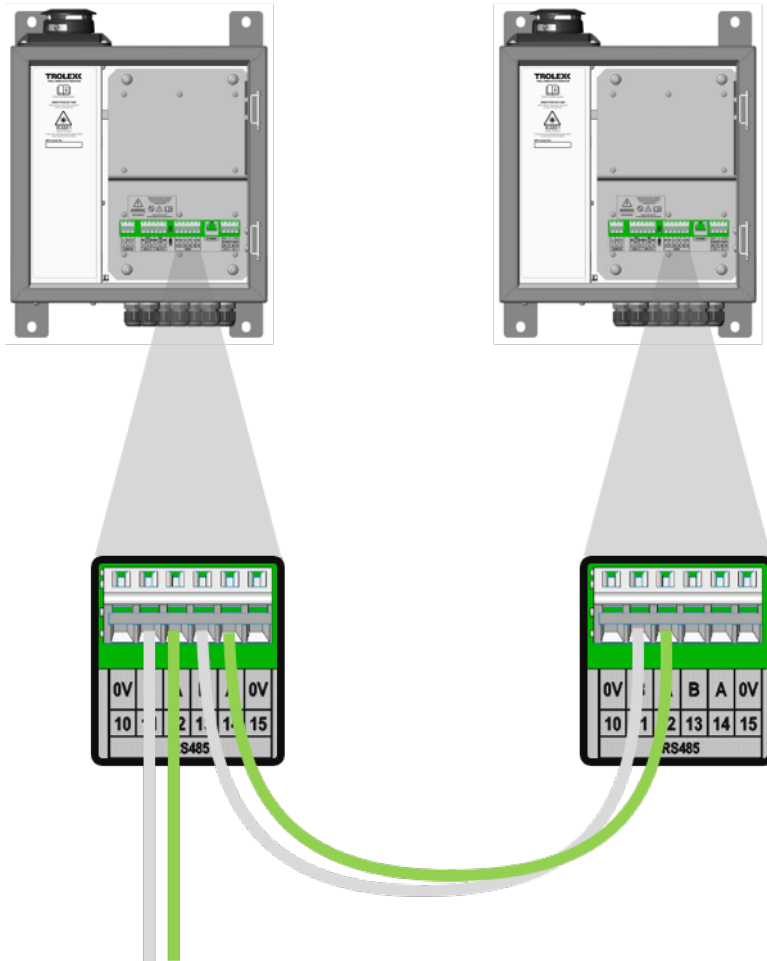

8.8 RS485 – line terminals

Some network installations may require a line termination resistor to be connected across RS485 lines A and B. A 120R resistor is available with SW4 set to off as standard, highlighted below.

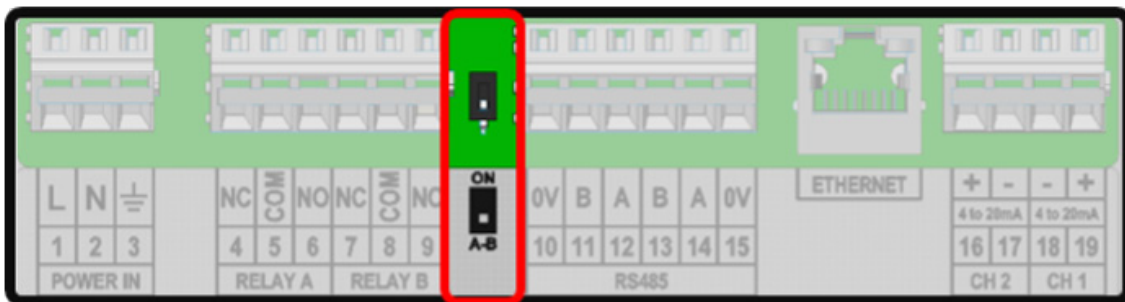

Once installed and powered for first time use, the Air XD requires some initial parameter set-up via the on-screen user interface. On connection to the communications network, the instrument will be selectable within the Trolex [Breathe](#) software and will begin to push data to the PC application.

9.1 First power on

Prior to commissioning and first use, the instrument should be inspected for any visible damage and integrity of the enclosure.

1. Ensure that the electrical connections are correctly installed, as described in **section 8.4**.
2. Ensure that the door is closed and secured.
3. Apply power to the Air XD.
4. A splash screen will be displayed for several seconds whilst the instrument auto configures.
5. Once configuration is complete, the Air XD will automatically display live data for all PM sizes.

9.2 [Breathe](#) software

The Trolex [Breathe](#) software is available for download and installation from Trolex Ltd. or via an authorised distribution partner and is specifically designed for the capture of data sets collected by the Air XD instrument. Installation and commissioning of the Trolex [Breathe](#) software is covered in a separate user manual and installation guide.

Note: The Trolex [Breathe](#) software is not required for general on-device Air XD operation and functionality.

10.1 Navigation

The Air XD information software is navigated using the on-device keypad and display. The keypad consists of four directional keys and a central enter key to allow the scrolling, selection and input of data into the instrument.

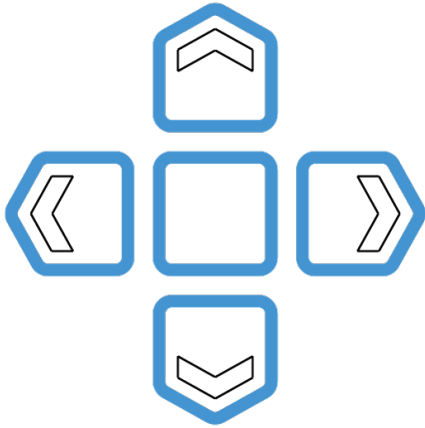

Directional keypad.



User interface.



'Up' navigation key.



'Down' navigation key.



'Left' and 'Right' navigation keys.



'Enter' key.

10.2 Main function keys

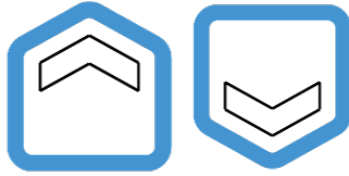

A single press of the 'Up' or 'Down' navigation key is used for the display functions below.

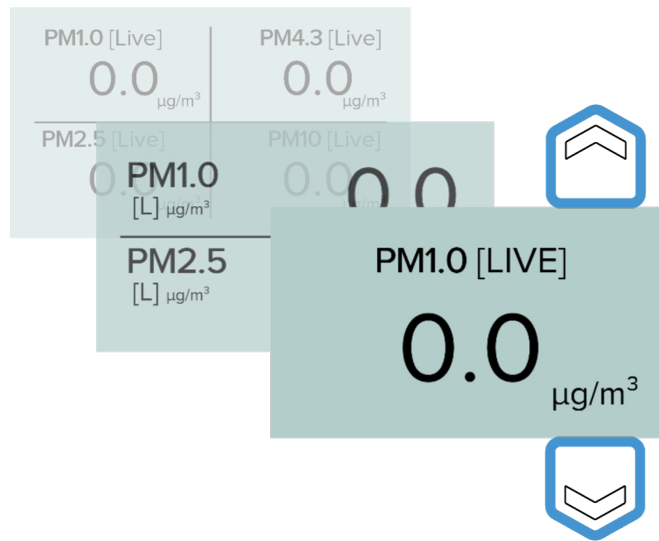

Navigate PM display value screens.

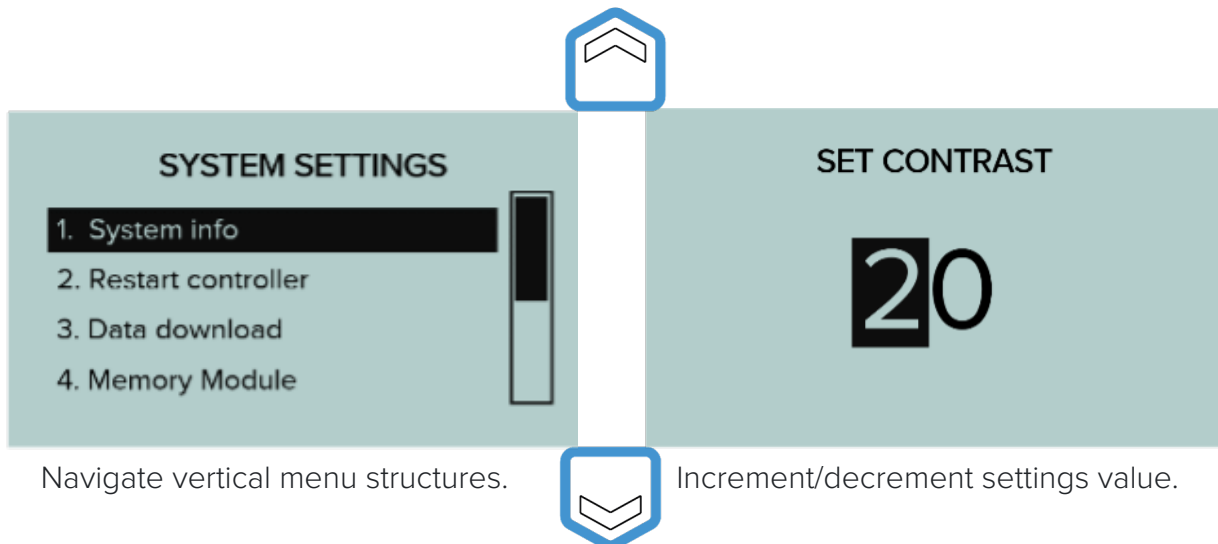

Navigate vertical menu structures.

Increment/decrement settings value.



A single press of the 'Left' or 'Right' navigation key is used for the display functions below.

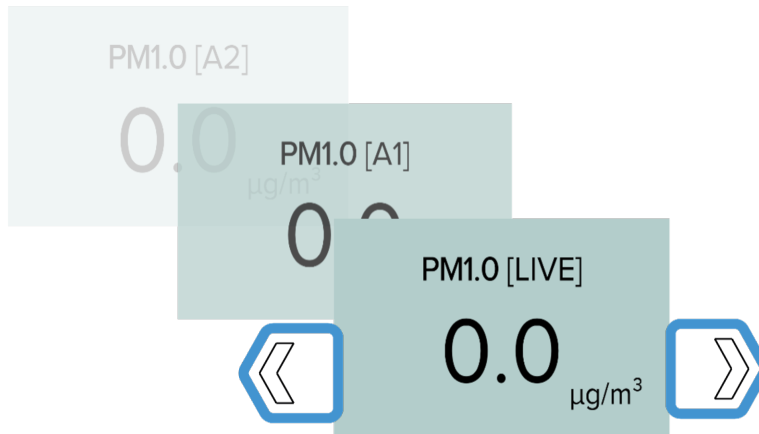

Cycle through "Live", "Average 1" and "Average 2" screens.

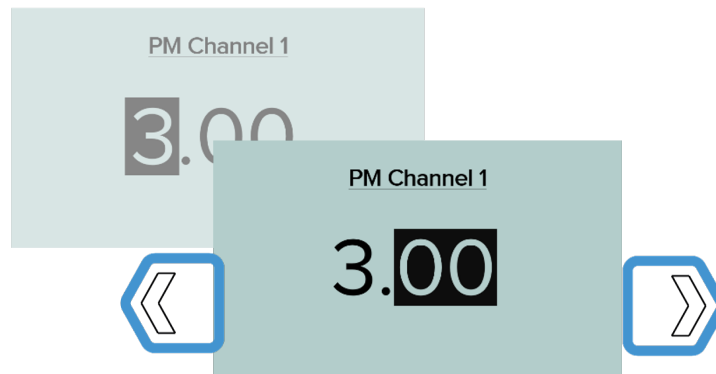

Cycle through entry parameters.



A single press of the 'Enter' key is used for the display functions below.

Cycle through PM values on data display screens.

Select highlighted option whilst in menu structures.

Confirm input value data entry.

10.3 Shortcut functions



Press and hold to cycle through previous display screen path.

Release to stop on a specific menu screen.



Press and hold to incrementally skip through numerical values.



During “Live” data display, press and hold the ‘Enter’ key to enter the main menu screen.

11.1 User interface display

On initial power up of the Air XD, particulate sampling will automatically start, and the graphical display will show the following screens. Once the instrument has been configured, with custom values assigned where required, user inputs will be saved in the instrument memory and on consecutive power cycles the Air XD instrument will always display the following start up screens.

Air XD power on > title card > “Live” data screen (default to all PM value display)



Title screen.

PM1.0 [Live] 0.0 $\mu\text{g}/\text{m}^3$	PM4.3 [Live] 0.0 $\mu\text{g}/\text{m}^3$
PM2.5 [Live] 0.0 $\mu\text{g}/\text{m}^3$	PM10 [Live] 0.0 $\mu\text{g}/\text{m}^3$

All PM values “Live”
Default landing screen).

11.2 PM value display map

The following map details the navigation through the Air XD PM value display screens. Users can select between the number of PM data channels displayed on screen, 1, 2, 4 or all, alongside the required data channel average (‘Live’, ‘Average 1’ or ‘Average 2’).

Title screen



**All PM values “Live”
Default landing screen)**

PM1.0 [Live] 0.0 $\mu\text{g}/\text{m}^3$	PM4.3 [Live] 0.0 $\mu\text{g}/\text{m}^3$
PM2.5 [Live] 0.0 $\mu\text{g}/\text{m}^3$	PM10 [Live] 0.0 $\mu\text{g}/\text{m}^3$



Dual channel values

PM4.3 [L] $\mu\text{g}/\text{m}^3$	0.0
PM10.0 [L] $\mu\text{g}/\text{m}^3$	0.0

PM1.0 [L] $\mu\text{g}/\text{m}^3$	0.0
PM2.5 [L] $\mu\text{g}/\text{m}^3$	0.0



Single channel values

PM1.0 [LIVE]	0.0 $\mu\text{g}/\text{m}^3$
--------------	------------------------------

PM2.5 [LIVE]	0.0 $\mu\text{g}/\text{m}^3$
--------------	------------------------------

PM4.3 [LIVE]	0.0 $\mu\text{g}/\text{m}^3$
--------------	------------------------------

PM10.0 [LIVE]	0.0 $\mu\text{g}/\text{m}^3$
---------------	------------------------------

TPC [LIVE]	0 counts
------------	----------



List channel values

PM1.0 [Live]	0.0 $\mu\text{g}/\text{m}^3$
PM2.0 [Live]	0.0 $\mu\text{g}/\text{m}^3$
PM4.3 [Live]	0.0 $\mu\text{g}/\text{m}^3$
PM10.0 [Live]	0.0 $\mu\text{g}/\text{m}^3$
TSP	0.0 $\mu\text{g}/\text{m}^3$

11.3 Top cap closed

If the units top cap is ‘closed’, then the live data will not be displayed.

Instead, a warning will be shown on screen with the backlight being set to red. The device settings can be accessed by pressing the ‘Enter’ key. When the top cap is opened then the screens will return to the live data display.



11.4 Settings structure

The following settings can be configured within the Air XD settings menu by selecting the required field when highlighted within the black selection bar.

Title screen

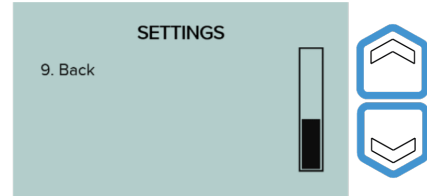
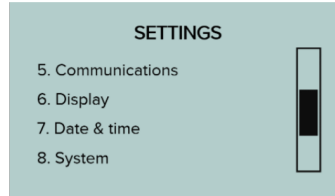
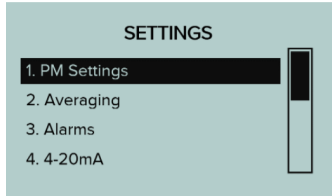

Press “Enter” to select from the list.

Each settings menu allows users to access the following information or selection options:

- **PM settings**
Configure and select custom PM values/ranges and map against instrument channels.
- **Averaging**
Configure and select averaging periods for PM values.
- **Alarms**
Configure and select on-device alarm functionality.
- **Communications**
Configure and select instrument communications protocols.
- **Display**
Configure the on-device display and graphical interface.
- **Date and time**
Configure the instrument date and time settings.
- **System**
Review, configure and update the instrument system settings.

11.5 Passcode protection

The device settings are passcode protected by default. Whenever a setting is changed then the user must enter a passcode before the change of setting is saved and implemented.

Note: By default the passcode is set to “1234”

The passcode is entered using the ‘up’ and ‘down’ keys to increment/decrement the digit. The ‘left’ and ‘right’ keys are used to change the selected digit. Once the code has been entered, press the ‘enter’ key.



If the passcode entered is correct, then the change of settings will be changed. If the passcode is incorrect then the settings will remain unchanged.

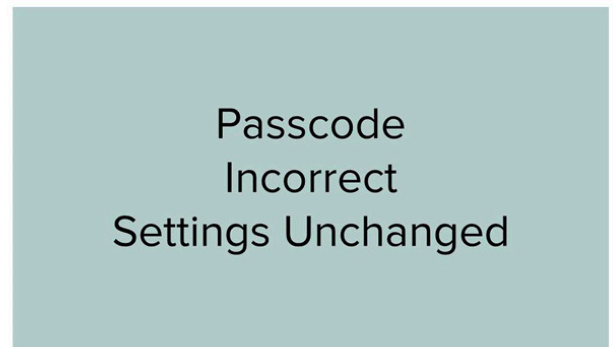
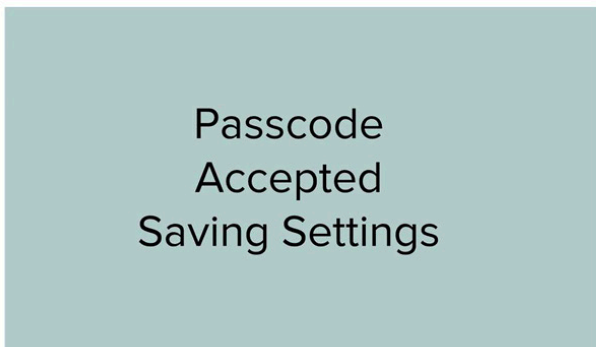

11.6 Change passcode

The settings passcode can be changed to a custom value using the “System” menu. Once the user has entered the new passcode they will be required to enter the previous passcode before the change takes place.

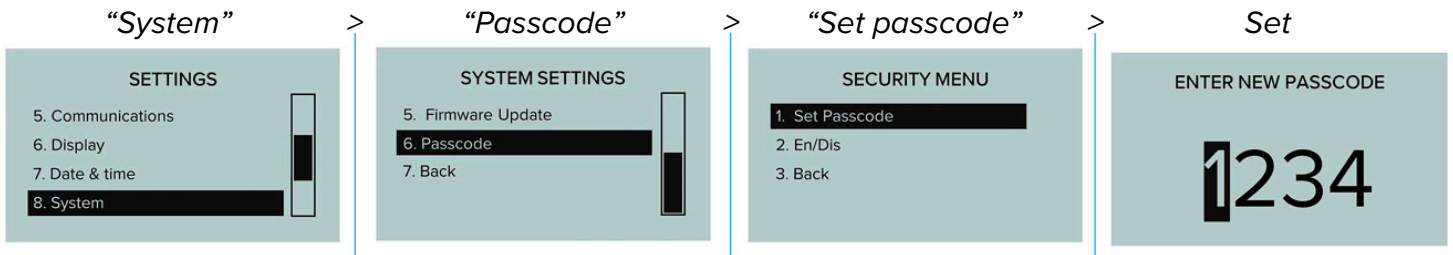

11.7 “Enable”/“Disable” passcode protection

Passcode protection of the device settings is enabled by default but can be disabled and re-enabled using the on-screen menus.

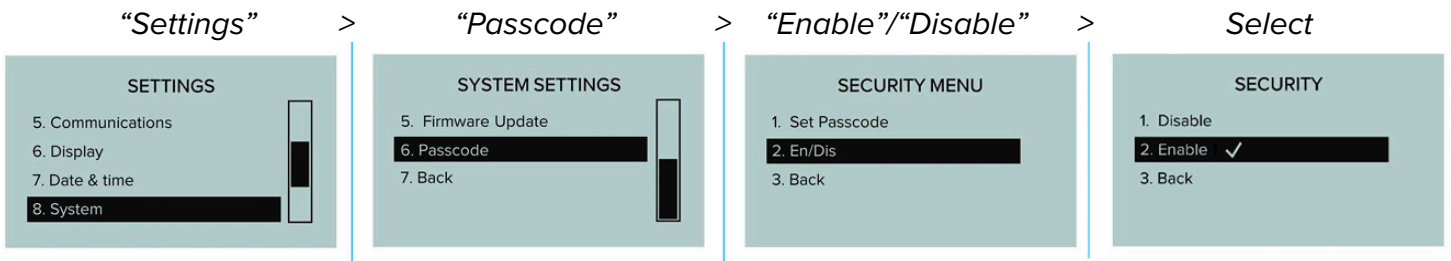

11.8 PM settings

Configure and map PM sizes against selected channels (“Ch1” to “Ch4”).

PM values can be set to range from 1 μm to 10 μm . Users can choose to display either mg/m^3 or $\mu\text{g}/\text{m}^3$ for all available channels.

Note: The instrument logs data in $\mu\text{g}/\text{m}^3$.

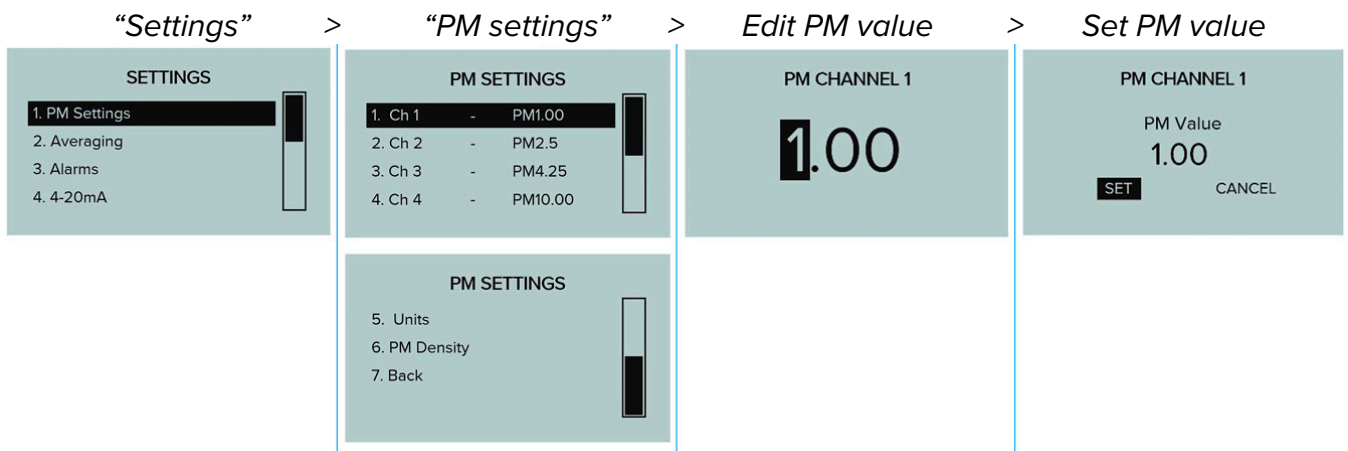

11.9 Setting custom PM values

The following map details the navigation through the Air XD user interface screens to set and configure custom PM values against channels 1 to 4, including TSP.

“Settings” > “PM settings” > Select channel for configuration.

PM channel settings



Cycle through values



Press 'enter' to select

Set PM value



Press 'enter' to select

11.10 PM density

Allows the user to set a custom PM density value for known particulates in the installation environment.

Note: The Air XD uses a PM density value to calculate the mass of known particulates in the installation environment (1.65 g/ml as default).

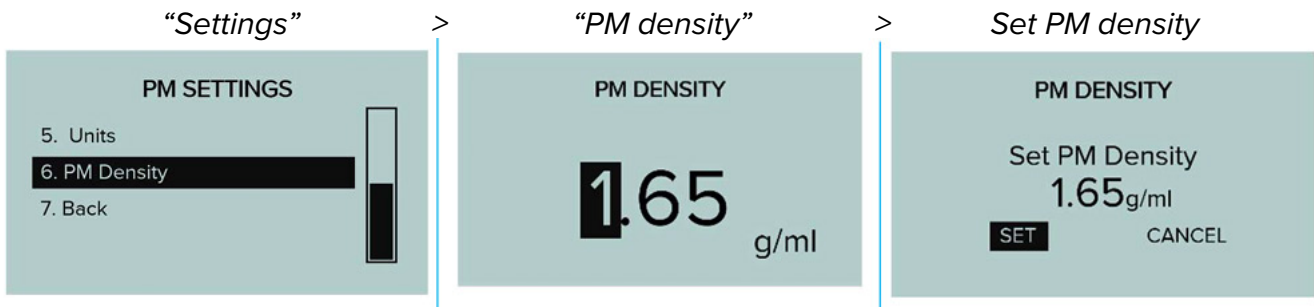

11.11 Averaging settings

These averaging settings allow the user to set two separate averaging periods or time bases for all PM channels, including TSP.

Users can select a range between 1 minute and 24 hours.

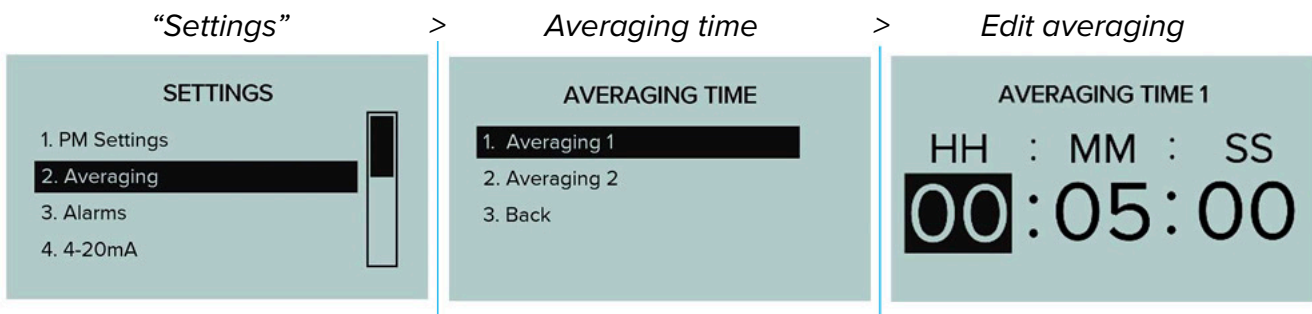

11.12 Alarm settings

The Air XD offers two user configurable alarms. Each alarm requires four parameters to be selected and configured. All alarms are logged in the Air XD event log.

- **Assigned a PM size/channel (PM1.0, PM2.5, PM4.25, PM10.0 and TSP)**
Select one of the four configured PM sizes or TSP as the alarm source.
- **Assigned a data source/channel**
Select whether to act on live data readings or one of the pre-configured averages (15 minutes to 8 hours).

- **Assigned a threshold ($\mu\text{g}/\text{m}^3$ and mg/m^3)**

Set the value at which the alarm will trigger ($1 \mu\text{g}/\text{m}^3$ to $9,999 \mu\text{g}/\text{m}^3$ or $0.1 \text{mg}/\text{m}^3$ to $6,553.5 \text{mg}/\text{m}^3$).

- **Assigned latching of non-latching behaviour**

Choose whether the alarm stays active once the fault condition is cleared or is self-clearing (non-latching). For non-latching selections, alarms will be cleared but the event will be logged.

Note: Once the alarm is triggered, the corresponding relay will then switch, and an alarm message is displayed on screen.



11.13 Channel select

The Air XD has two alarm channels that can be assigned one of four particulate sizes or TSP.

Note: The current applied value is highlighted by the 'selection tick'.

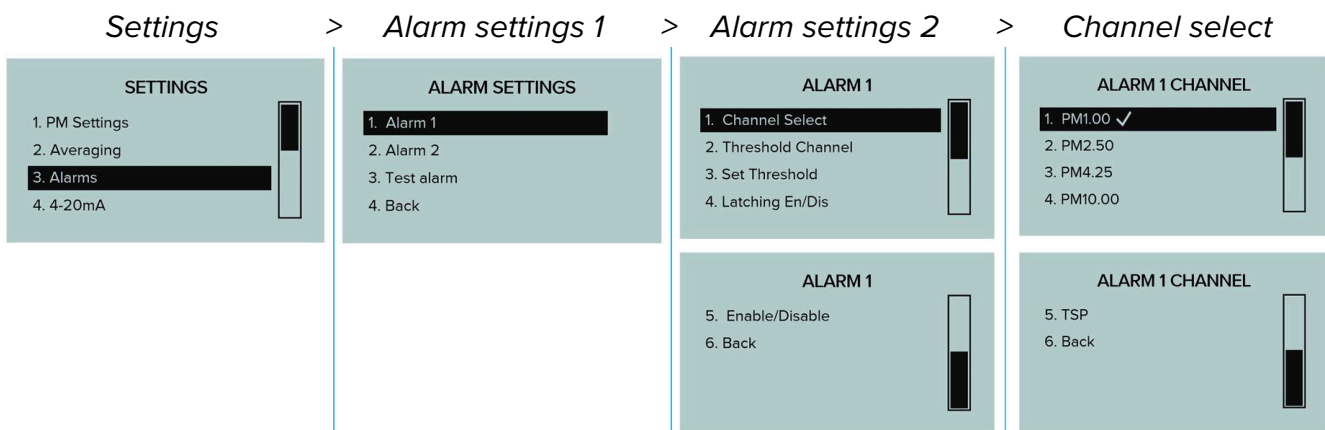

11.14 Threshold channel

Select and assign an alarm to a specified data source.

Note: The current applied value is highlighted by the ‘selection tick’.

“Settings” > Alarm settings 1 > Alarm settings 2 > Threshold select

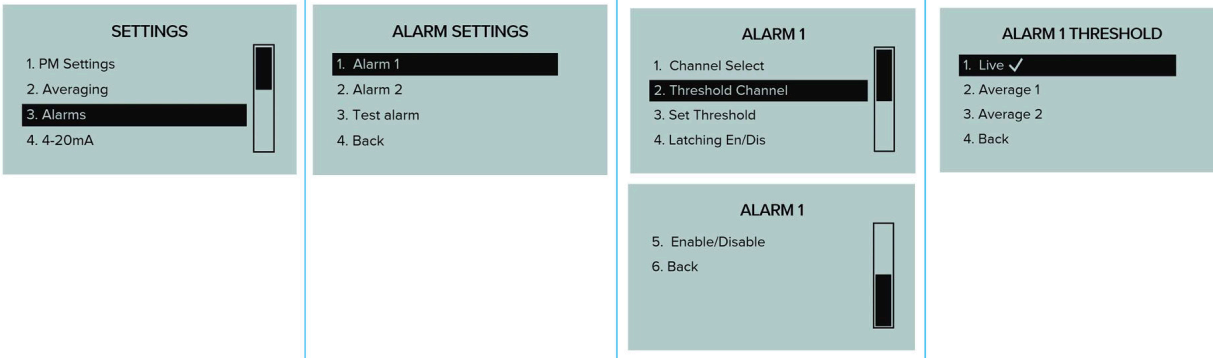

11.15 Set alarm threshold

Set the threshold value, which activates the alarm. Threshold values can be configured between 1 µg/m³ to 9,999 µg/m³ or 0.1 mg/m³ to 6,553.5 mg/m³.

Alarm settings 1 > Alarm settings 2 > Alarm threshold > Set alarm threshold

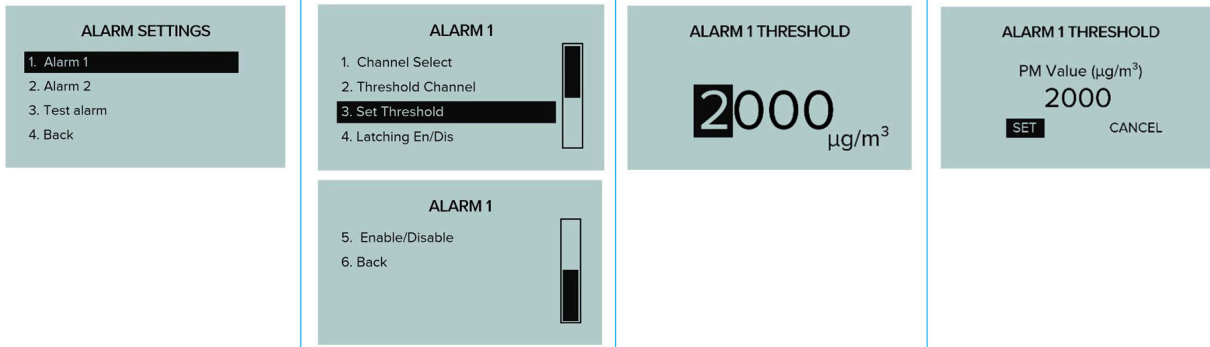

11.16 Alarm latching

Configure the latching behaviour for selected alarm.

Note: The current applied value is highlighted by the ‘selection tick’.

Alarm settings 1 > Alarm settings 2 > Set alarm latching

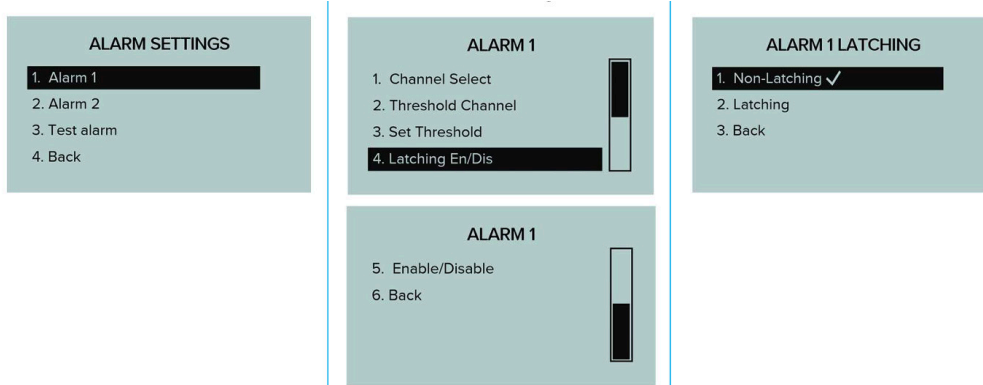

11.17 “Enable”/“Disable” alarm

Enable to disable audio-visual alarms for selected alarm.

Note: The current applied value is highlighted by the ‘selection tick’.

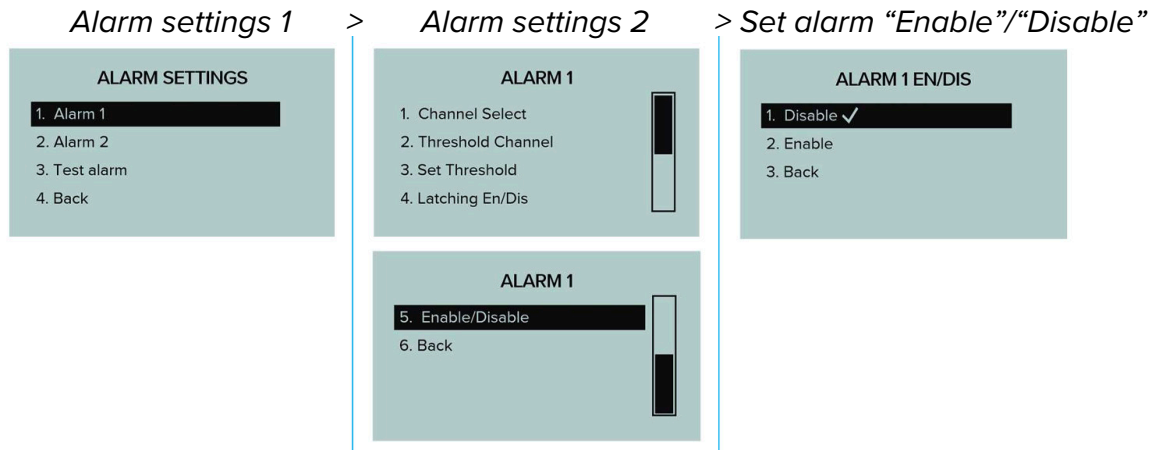

11.18 4 - 20 mA outputs

The Air XD offers two 4 - 20 mA outputs. Each 4 - 20 mA output requires two parameters to be selected and configured to determine the functionality of each analogue output.

- **Assigned a PM size/channel (PM1.0, PM2.5, PM4.25, PM10.0 and TSP)**
Select one of the four configured PM sizes or TSP as the alarm source.
- **Assigned a data channel (“Live”, “Average 1” or “Average 2”)**
Select one of the three data sets to assign the selected 4 - 20 mA output to.
- **Assigned the full-scale range of the channel**
A full-scale range of 2,000 $\mu\text{g}/\text{m}^3$, for example, will output 20 mA for a value greater or equal to 2,000 $\mu\text{g}/\text{m}^3$, and a value of 0 $\mu\text{g}/\text{m}^3$ will always have an output of 4 mA.
- **“Enable”/“Disable” the channel**
A disabled channel will output 0 mA.

During instrument start up and initialisation, each 4 - 20 mA output will perform a calibration routine, which involves sweeping the output from 0 - 20 mA before returning to 4 mA.

After this has been completed, the output will return to configured functionality.

11.19 Select PM channel

The Air XD has two 4 - 20 mA outputs that can be assigned to one of four particulate sizes or TSP.

Note: The current applied value is highlighted by the ‘selection tick’.

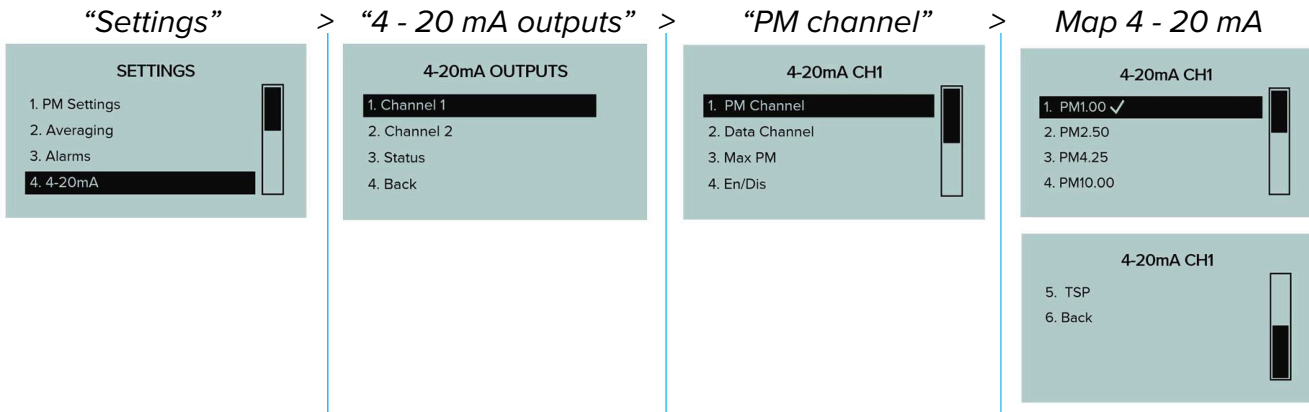

11.20 Map 4 - 20 mA to data channel

Map the selected 4 - 20 mA output to the required data channel (“Live”, “Average 1” or “Average 2”).

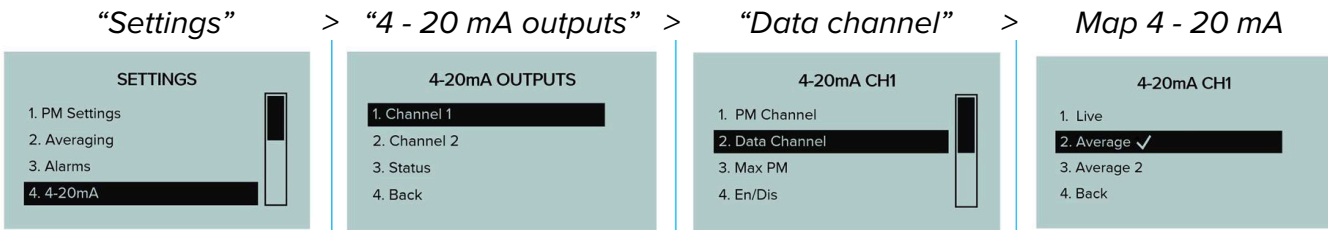

11.21 Set maximum PM value

Set the 4 - 20 mA scaling range for each 4 - 20 mA output. (0 to 9,999 $\mu\text{g}/\text{m}^3$ or 0.1 to 6,553 mg/m^3).

“4 - 20 mA outputs” > “4 - 20 mA channel” > “4 - 20 mA max. PM” > Set max. PM

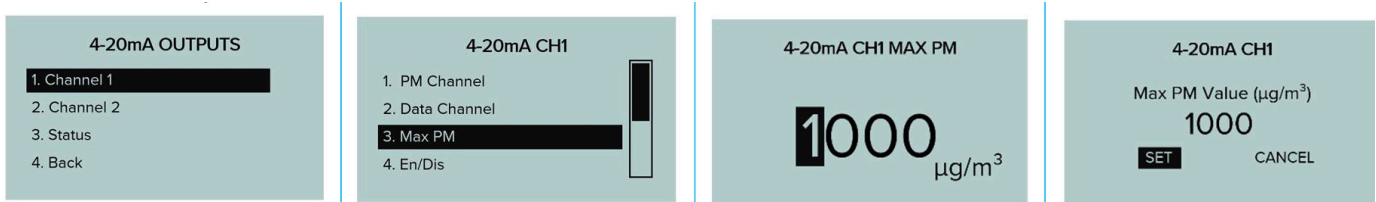

11.22 “Enable”/“Disable”

Enable or disable 4 - 20 mA outputs.

Note: The current applied value is highlighted by the ‘selection tick’.

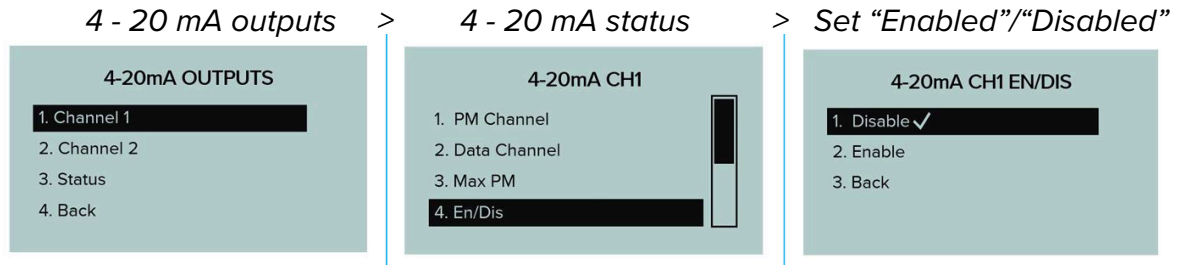

11.23 Status

Check the overview status of the 4 - 20 mA channels.

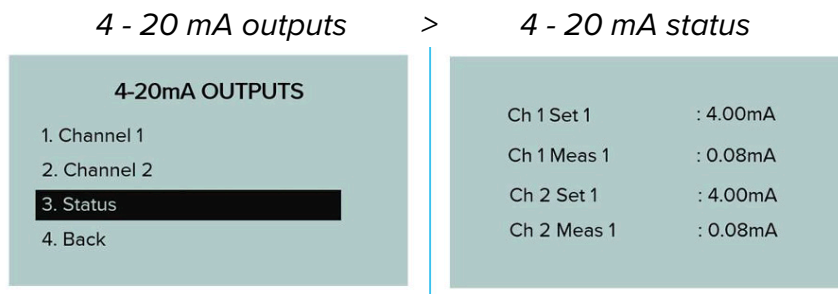

11.24 Communications

The Air XD offers two selectable communications protocols, RS485 MODBUS and Ethernet MODBUS TCP/IP secured by TLS 1.2, that can be used to configure and network the instrument. Each communication protocol requires the network and connection parameters to be correctly configured on the instrument and network where applicable.

11.25 Ethernet communications

The Air XD supports communications over ethernet MODBUS TCP/IP. Ethernet communications requires configuration of the parameters shown in the system menus below to establish successful communication with the designated server.

A separate setup guide is available from Trolex Ltd. The following is an overview of the ethernet communications in the device.

Note: The MODBUS TCP/IP communicates over ‘Port 502’.

Settings > Communications > Ethernet

11.26 Network status

Check the overview status of the connected network.

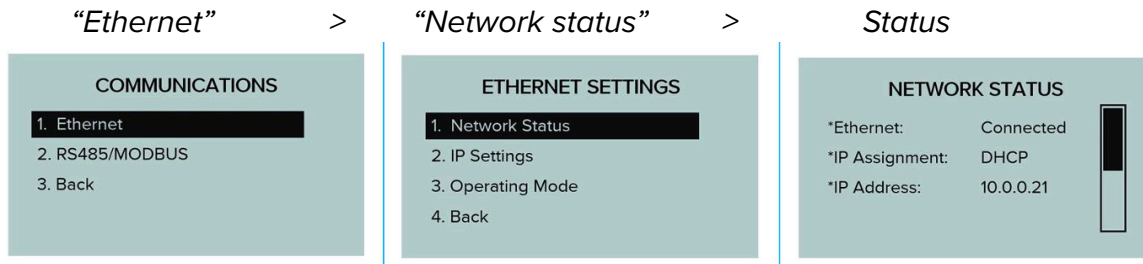

11.27 IP settings

The Air XD IP settings can be configured based on application requirements. From the "IP Settings" menu users can select and configure the following.

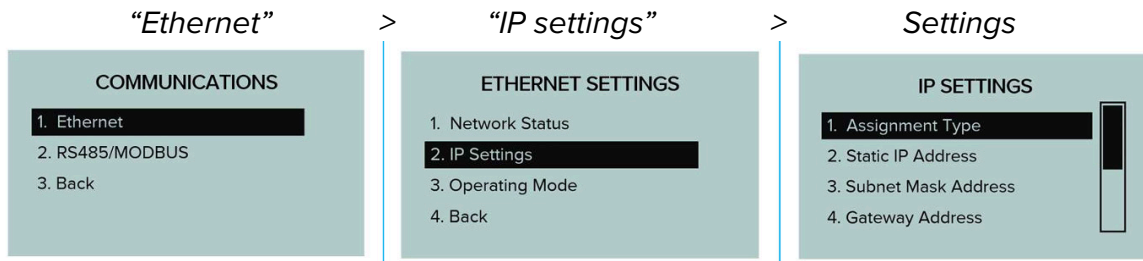

- Assignment type
- Static IP address
- Subnet mask address
- Gateway address
- Primary DNS
- Secondary DNS

11.28 Ethernet operating mode

The Air XD can be configured to communicate via MODBUS TCP direct to a PC or server running a MODBUS client.

Note: Selection of the [TrolexiCore](#) option allows the data recorded by the Air XD instrument to be pushed direct to an installed and running [TrolexiCore](#) API server. (Not yet implemented.)

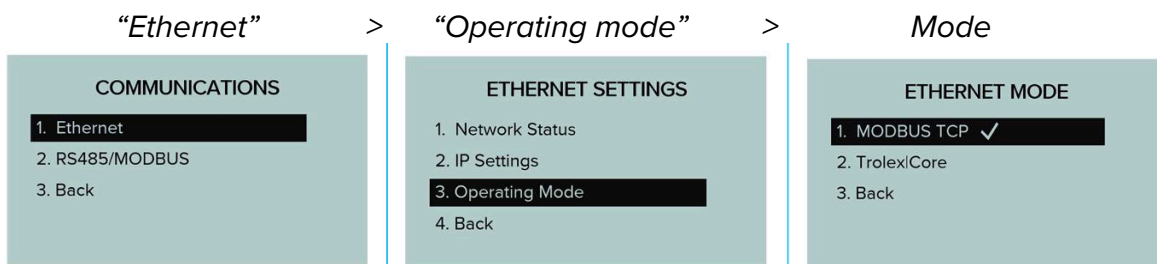

11.29 Ethernet connection status

The connection status of the Air XD can be viewed by pressing the ‘left’ arrow key from the “PM Value” readings screen. The status screen lists the connection type, connection status and instrument IP address.

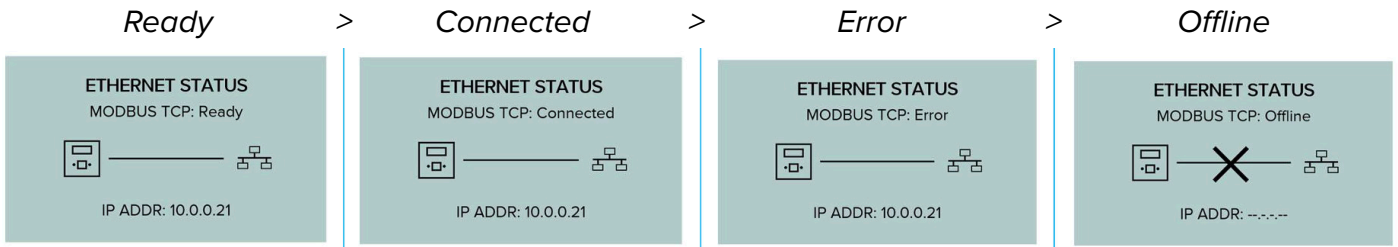

11.30 RS485 MODBUS communications

The Air XD has configurable MODBUS baud rates and a user-configurable address. It is possible to configure the MODBUS device address and baud rate through the on-device display menu.

“Settings” > “Communications” > “RS485/MODBUS”

11.31 Set baud rate

The Air XD instrument baud rate can be selected and assigned from a pre-configured list of options.

Note: The current applied value is highlighted by the ‘selection tick’.

- 4,800
- 9,600
- 14,400
- 19,200
- 38,400
- 57,600
- 115,200 (default)

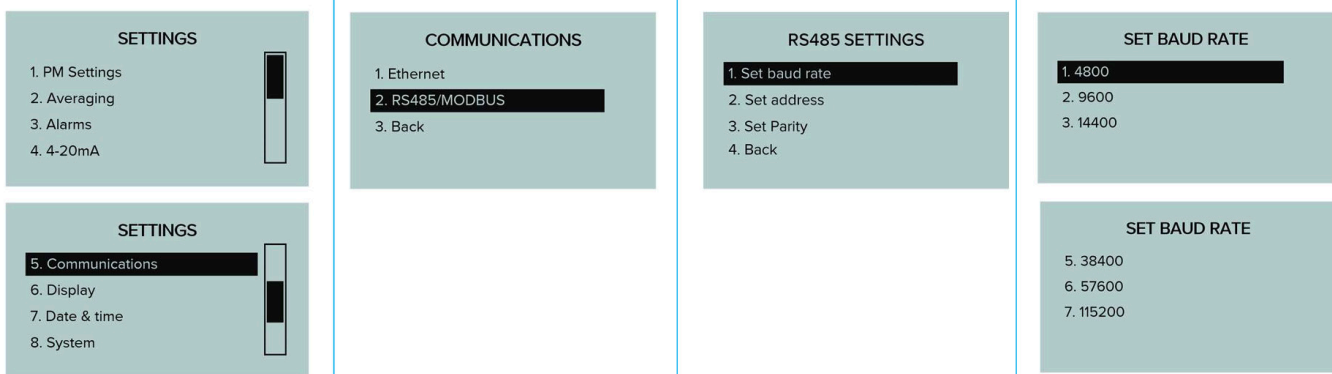

11.32 Set device address

The Air XD instrument address is user selectable and can be configured between 001 and 255.

“Communications” > *“RS485 MODBUS”* > *“MODBUS address”* > *“Set MODBUS address”*



11.33 Set communications parity

The Air XD instrument parity bit can be selected and assigned from a pre-configured list of options.

Note: The current applied value is highlighted by the ‘selection tick’.

“Communications” > *“RS485 MODBUS”* > *“Select parity”*

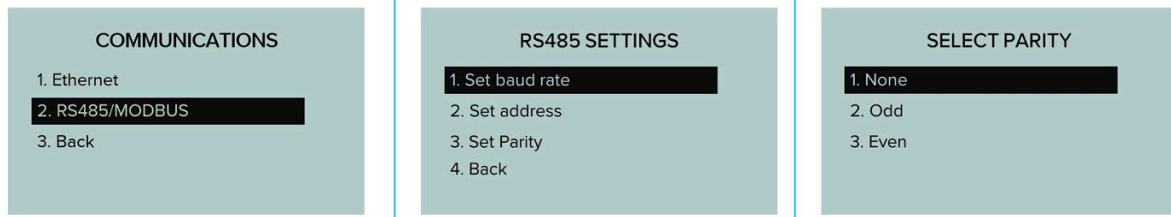

11.34 Display

The Air XD has a 128 x 64 dot matrix display with backlight. Users can select and configure display contrast, backlight colour and brightness. It is also possible to set power saving mode with display sleep functionality.

11.35 Adjusting display contrast

The Air XD display can be adjusted to align the contrast ratios with the installation environment.

“Settings” > *“Display”* > *Adjust contrast* > *Set contrast*

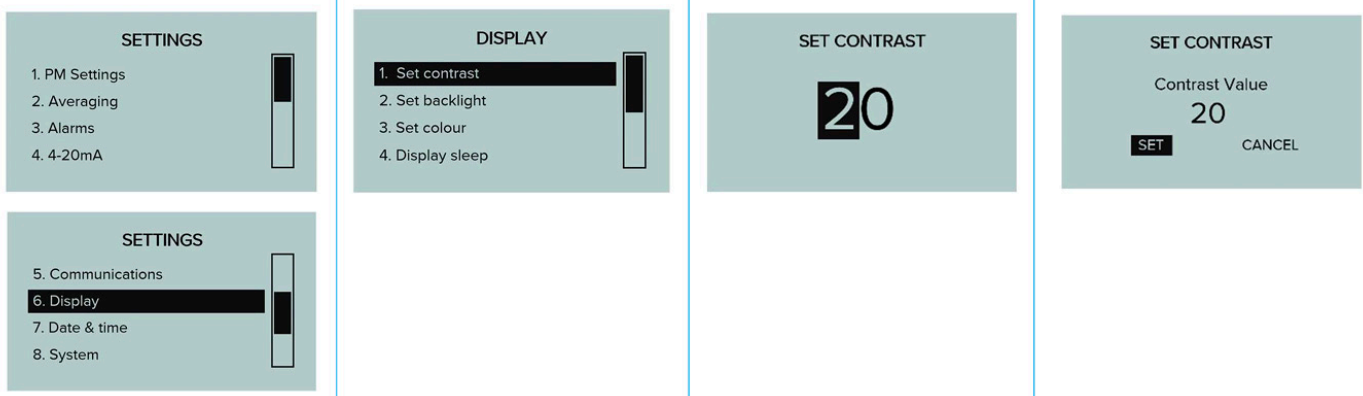

11.36 Set display backlight

The Air XD display can be adjusted to align the backlight brightness with the installation environment.

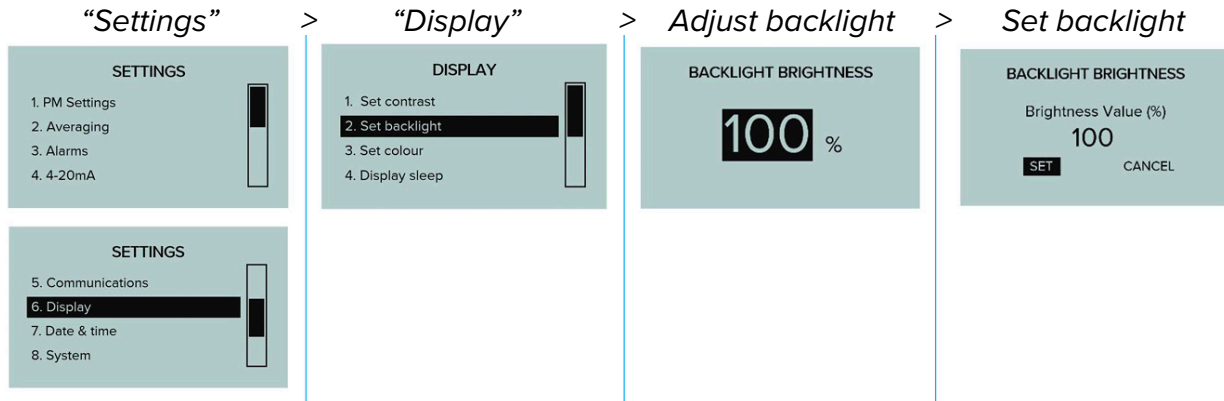

11.37 Set display colour

The Air XD display can be adjusted to configure the on-screen colour profile.

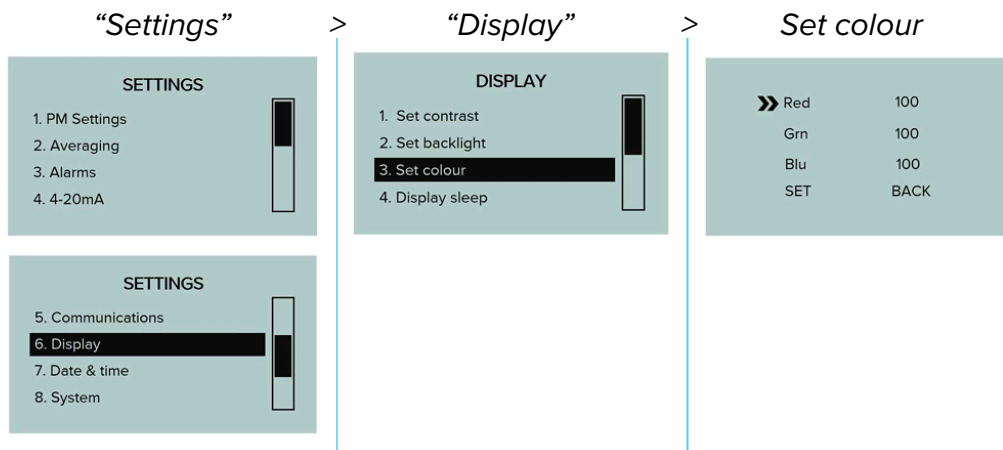

11.38 Set display sleep

The Air XD display can be set to enter sleep mode to allow for power saving where required.

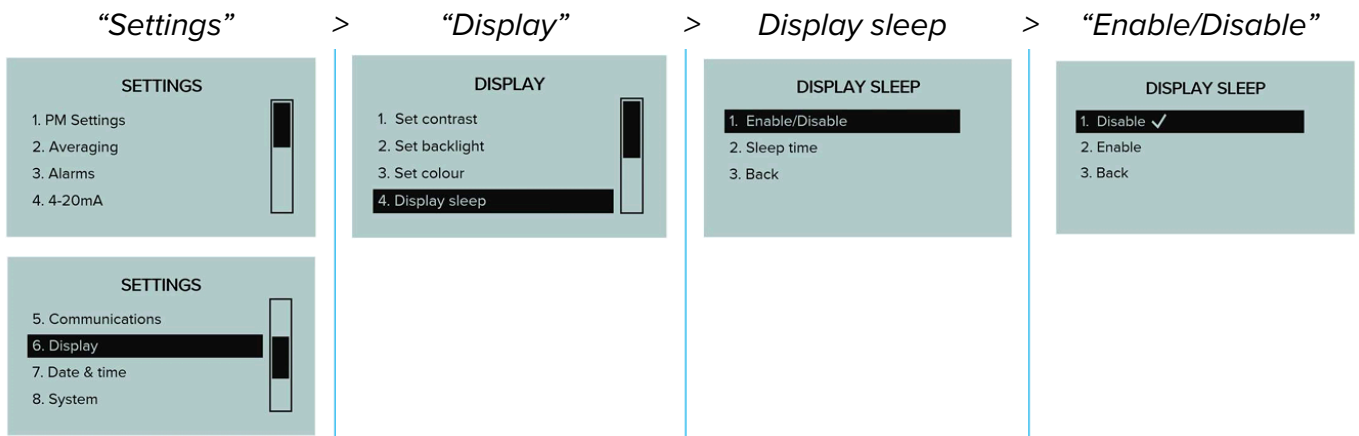

The Air XD display can also be configured to sleep after a chosen time period.

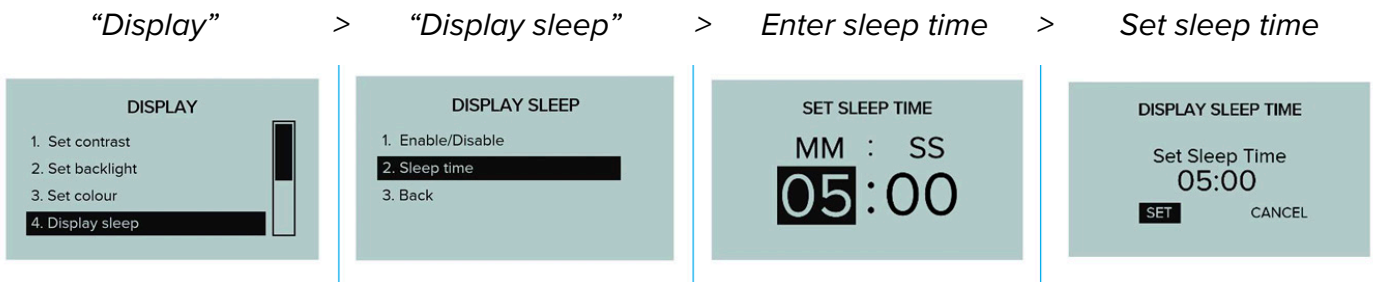

11.39 Date and time

The Air XD date and time can be configured to suit the installation location.

11.40 Set date

Configure and edit the date stamp logged by the Air XD instrument.

Note: Date format DD/MM/YYYY.

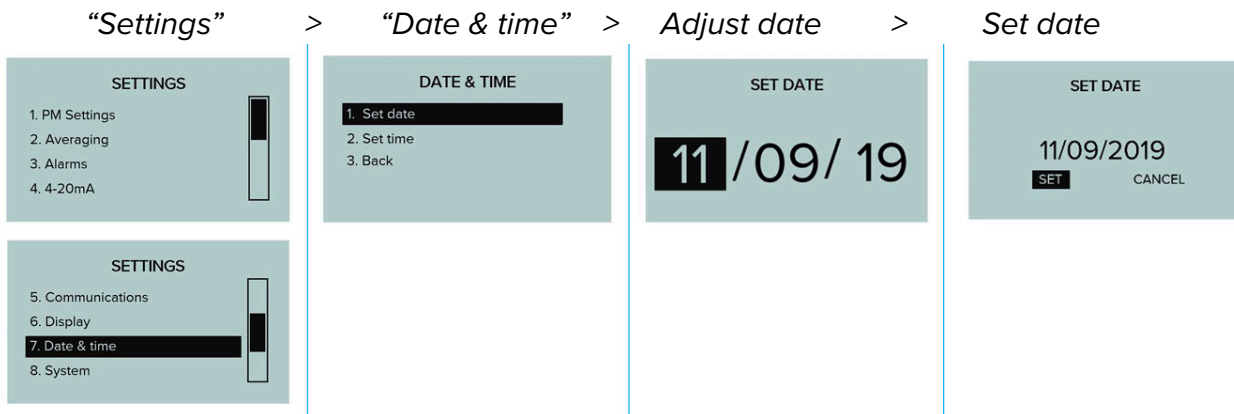

11.41 Set time

Configure and edit the time stamp logged by the Air XD instrument.

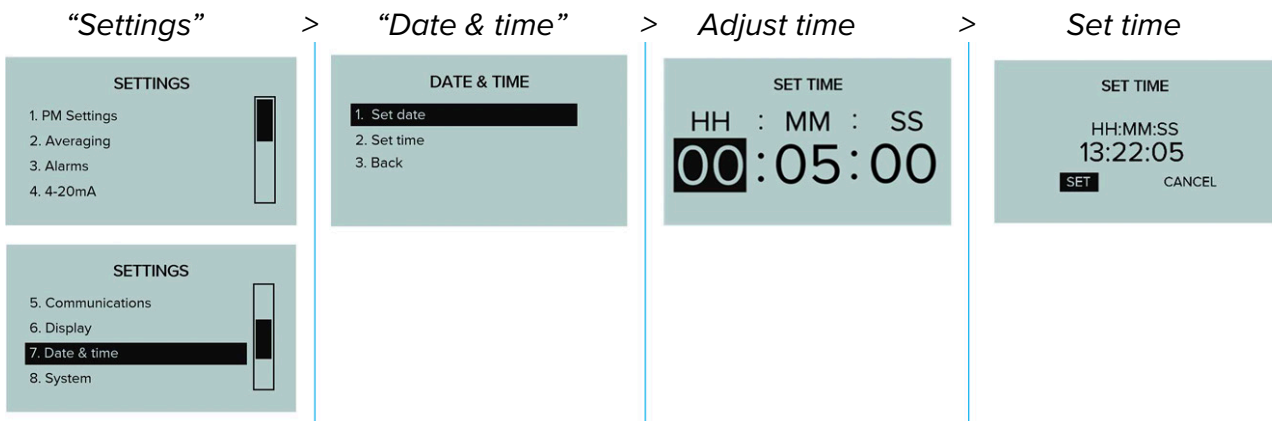

11.42 System

The Air XD “System” menu allows users to access system performance, serial information, update firmware and restart the instrument.

11.43 System information

The “System info” menu allows users to view the functional status of the Air XD instrument.

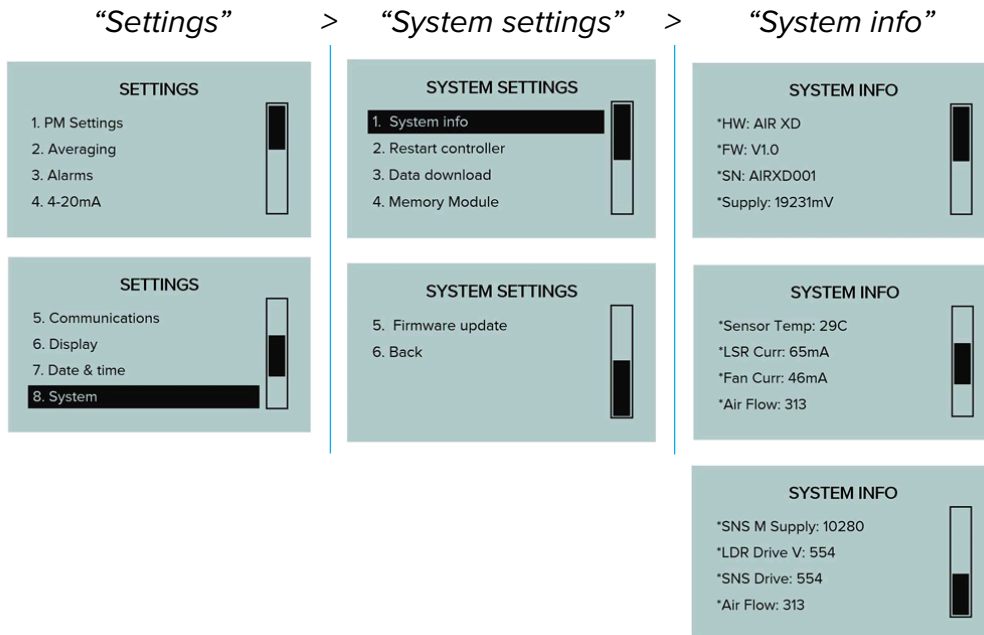

11.44 Restart controller

The Air XD instrument can be forced to restart and reboot through the ‘Restart controller’ menu.

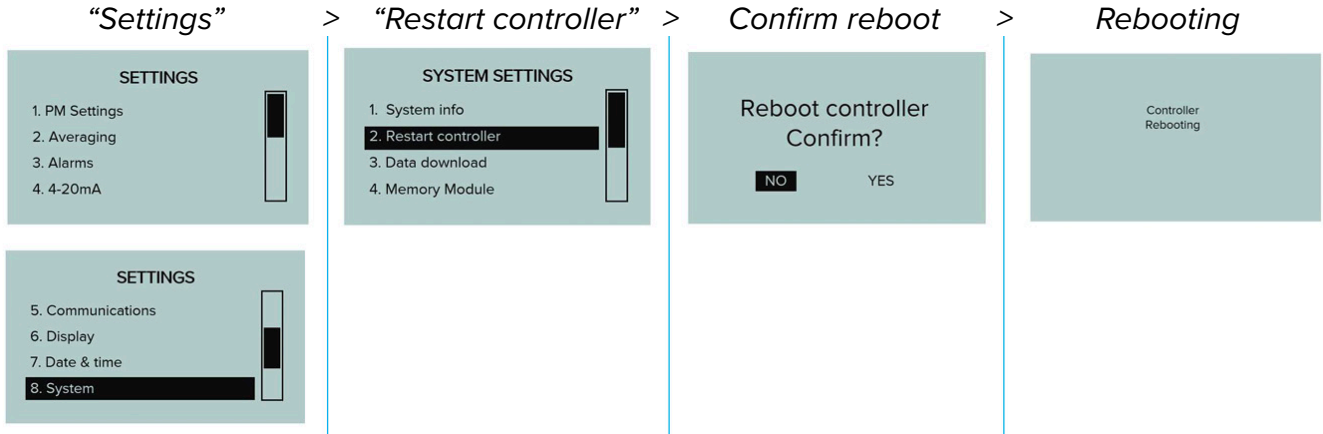

11.45 Data download

The Air XD allows users to download collected data sets via the “Data Download” menu. Data is stored on the instrument internal memory and can be locally downloaded onto a removable USB device when connected via the external USB connector positioned at the base of the instrument.

Note: It is recommended that a USB with at least 8 GB of storage capacity is used for local data download. The Air XD only supports **FAT32** file formatted USB devices. Trolax recommends the use of a dedicated USB device formatting tool, such as **AOMEI Partition Assistant** or similar when converting large storage sizes to **FAT32** file format.

- Collected data can be retrieved from the Air XD instrument by either selecting the “Download All” or “Download New” data sets.

- Selecting the “Download All” tab will notify users of the number and total size of the files to be downloaded.
- Selecting the “Download New” tab will notify users of the number and total size of the files to be downloaded.*

*This function works based on reading the last file name downloaded to the connected USB device and only downloading the data set recorded after the last download.

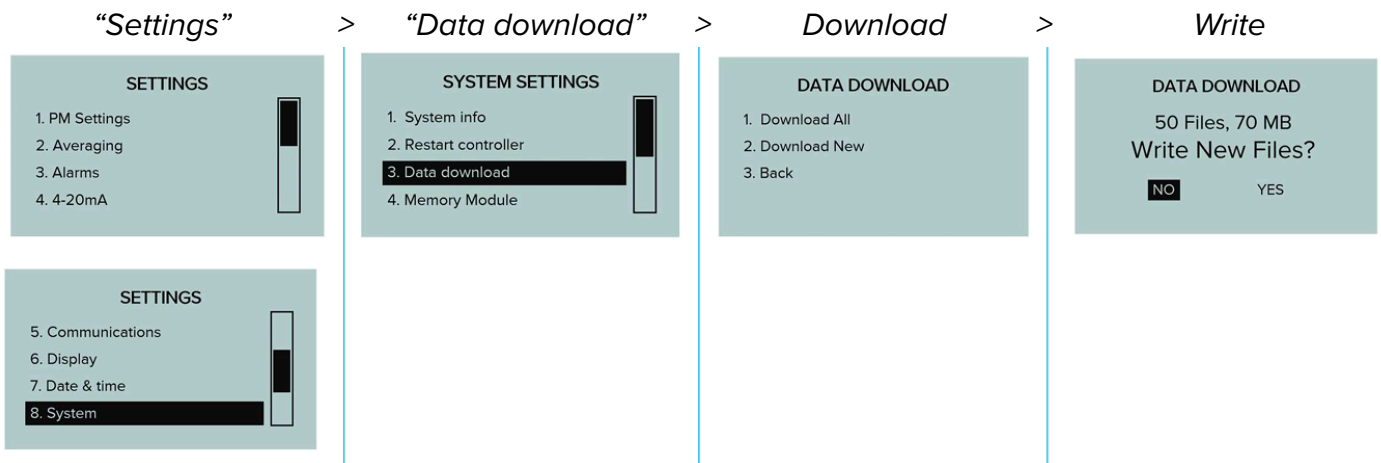

Data download functionality is only available when a remote USB device is connected to the Air XD. The following screen will be displayed if a USB device is not connected or cannot be identified by the instrument.

“Settings” > “Data Download” > “Download” > “NO USB DEVICE”

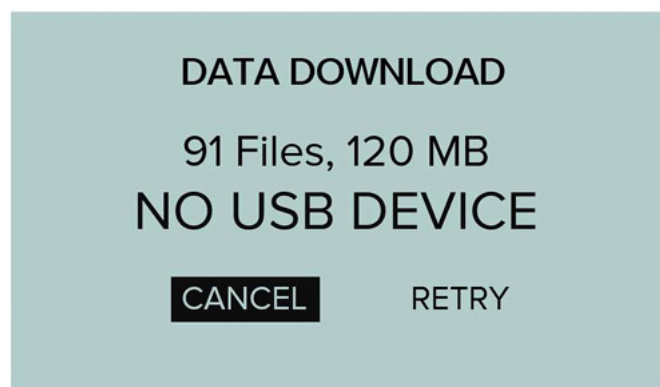

11.46 Memory module

The Air XD contains an internal memory module that is used to locally store collected data sets on the instrument. The module can be configured from the settings menu to allow local data collection to take place or to stop the Air XD from writing to the internal memory.

For the majority of applications, the internal memory module will be used and configured to allow the Air XD instrument to locally store data as well as push data to the Air X software via selected communications channels.

For applications that may require power saving functionality, the internal memory module can be de-selected.

Note: The current selection is highlighted by the ‘selection tick’.

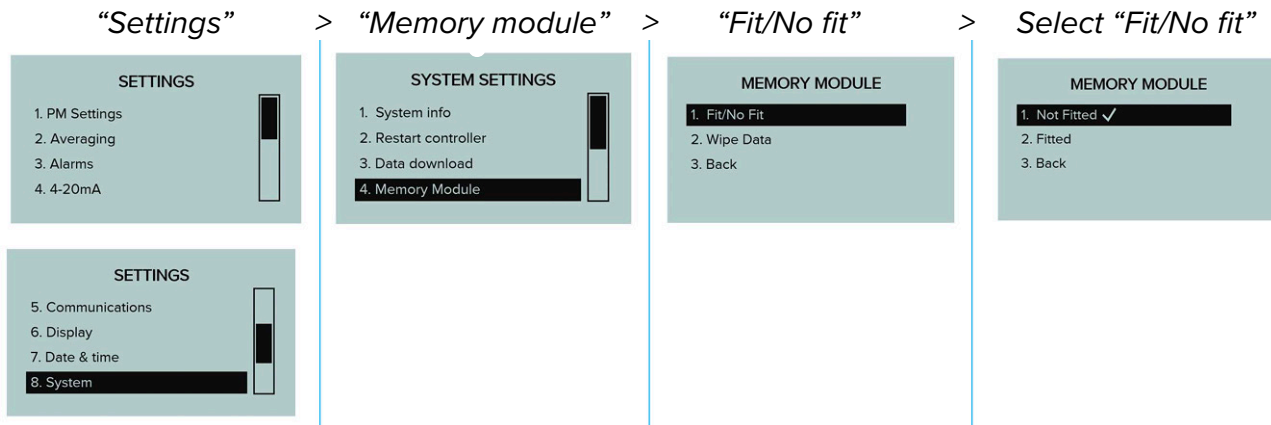

The internal memory module contains 8 GB of storage capacity, which, depending on the frequency of data collected and written, may require clearing. To clear the data set stored on the instrument, follow the on-screen functions detailed below.

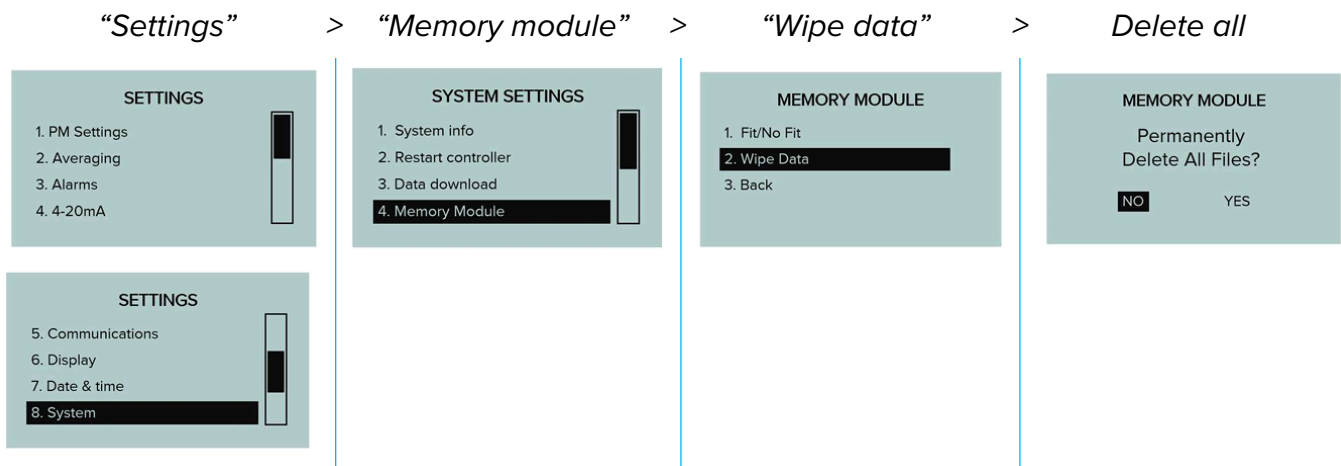

11.47 Firmware update

On notification of a firmware update and release, the Air XD and internal memory module can be updated via the firmware update menu below. The instrument requires the update to take place via the connection of an external USB device loaded with the latest firmware.

See **section 13** for full details on how to update for full details on how to update the firmware of the device.

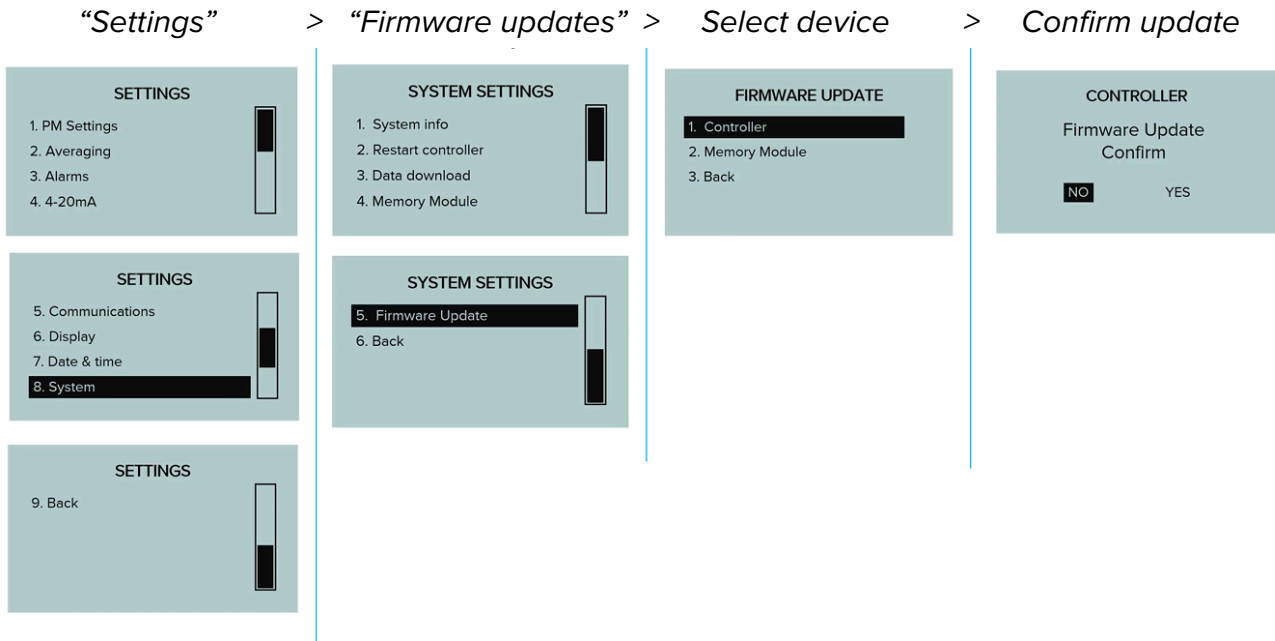

11.48 Relay override

If the alarms are enabled, in normal operation the relays will switch over if the assigned alarm threshold is exceeded. In some applications it may be necessary to override the relays to switch on a piece of equipment manually even if the alarm threshold has not been exceeded. To allow this functionality, coil registers (13 and 14) are provided for overriding the relays.

To move a relay to the normally open position, write '1' to the corresponding relay. To place the relays back under the control of the alarms by writing '0' to the relay.

The relays can also be overridden even when the alarms are disabled.

11.49 Watchdog

The Air XD contains an electronic watchdog to detect and recover from malfunctions without requiring input from the user. Once a device anomaly or malfunction has been detected, the unit will automatically implement a restart sequence.

The instrument will take up to 10 seconds to initiate a soft reset. On recovery from a soft reset, the time based averages are restored and the instrument will continue to log data from the point recorded before the watchdog reset.

Note: In the event of a hard reset, time based averages are reset to factor default (removal of power, then re-application).

12.1 Default settings

The Air XD has been programmed with factory default settings prior to delivery, which are detailed in the table below:

Number of channels	5
PM values	PM1.0, PM2.5, PM4.25, PM10 and TSP
Data averaging time 1	15 minutes
Data averaging time 2	8 hours
Display units	$\mu\text{g}/\text{m}^3$
RS485 baud rate	115,200
RS485/MODBUS	Enabled
Ethernet	Optional
4 - 20 mA range	0 - 2,000 $\mu\text{g}/\text{m}^3$ or 0 - 6,553.5 mg/m^3
4 - 20 mA	Mapped to average data
Alarms	Disabled
Alarm thresholds	1,000 $\mu\text{g}/\text{m}^3$
Alarm 1	“Channel 3”
Alarm 2	“Channel 4”
Alarm latching	Enabled

12.2 On-site configuration

The Air XD instrument can be configured to user requirements following the procedures outlined in **section 11**, using the on-device screen and buttons/user interface. The [Breathe](#) software also supports on-site custom configuration.

12.3 MODBUS addresses

The Air XD contains the following three MODBUS registers:

“Input Register” (function code “4”)

This is a read-only register containing factory programmed instrument parameters, including serial numbers, firmware versions and live data sets.

Register	Description	Data type	Units
0	Product TX number	Uint16_t	
1	Firmware version (major)	Uint16_t	
2	Firmware version (minor)	Uint16_t	
3	Firmware version (patch)	Uint16_t	
4	Serial number (characters 1 and 2)	Char	Ascii format
5	Serial number (characters 3 and 4)	Char	
6	Serial number (characters 5 and 6)	Char	
7	Serial number (character 7 and 18)	Char	

8	Serial number (characters 9 and 10)	Char	
9	Bin 0 to 0.46 μm	Uint16_t	Counts
10	Bin 1 to 0.66 μm	Uint16_t	Counts
11	Bin 2 to 0.89 μm	Uint16_t	Counts
12	Bin 3 to 1.17 μm	Uint16_t	Counts
13	Bin 4 to 1.47 μm	Uint16_t	Counts
14	Bin 5 to 1.80 μm	Uint16_t	Counts
15	Bin 6 to 2.5 μm	Uint16_t	Counts
16	Bin 7 to 3.5 μm	Uint16_t	Counts
17	Bin 8 to 4.51 μm	Uint16_t	Counts
18	Bin 9 to 5.76 $\mu\text{g}/\text{m}$	Uint16_t	Counts
19	Bin 10 to 7.25 $\mu\text{g}/\text{m}$	Uint16_t	Counts
20	Bin 11 to 9 $\mu\text{g}/\text{m}$	Uint16_t	Counts
21	Bin 12 to 11 μm	Uint16_t	Counts
22	Bin 13 to 13 μm	Uint16_t	Counts
23	Bin 14 to 15.01 μm	Uint16_t	Counts
24	Bin 15 to 17.01 μm	Uint16_t	Counts
25	Bin 16 to 19.02 μm	Uint16_t	Counts
26	Bin 17 to 21.02 μm	Uint16_t	Counts
27	Bin 18 to 5.76 $\mu\text{g}/\text{m}$	Uint16_t	Counts
28	Bin 19 to 26.51 $\mu\text{g}/\text{m}$	Uint16_t	Counts
29	Bin 20 to 29.51 $\mu\text{g}/\text{m}$	Uint16_t	Counts
30	Bin 21 to 32.51 $\mu\text{g}/\text{m}$	Uint16_t	Counts
31	Bin 22 to 35.51 $\mu\text{g}/\text{m}$	Uint16_t	Counts
32	Bin 23 to 38.51 $\mu\text{g}/\text{m}$ (140 $\mu\text{g}/\text{m}$ extended)	Uint16_t	Counts
33	Sampling period	Uint16_t	Counts
34	Sample flow rate	Uint16_t	0.01 ml/s/bit
35	Sensor temperature	Uint16_t	0.01°C/bit
36	Sensor humidity	Uint16_t	0.01%/bit
37	PM A size (lower 16 bits)	Float32_t	$\mu\text{g}/\text{m}^3$
38	PM A size (upper 16 bits)	Float32_t	$\mu\text{g}/\text{m}^3$
39	PM B size (lower 16 bits)	Float32_t	$\mu\text{g}/\text{m}^3$
40	PM B size (upper 16 bits)	Float32_t	$\mu\text{g}/\text{m}^3$
41	PM C size (lower 16 bits)	Float32_t	$\mu\text{g}/\text{m}^3$
42	PM C size (upper 16 bits)	Float32_t	$\mu\text{g}/\text{m}^3$
43	PM D size (lower 16 bits)	Float32_t	$\mu\text{g}/\text{m}^3$
44	PM D size (upper 16 bits)	Float32_t	$\mu\text{g}/\text{m}^3$
45	TSP (lower 16 bits)	Float32_t	$\mu\text{g}/\text{m}^3$
46	TSP (upper 16 bits)	Float32_t	$\mu\text{g}/\text{m}^3$
47	PM A "Average 1" (lower 16 bits)		

48	PM A “Average 1” (upper 16 bits)		
49	PM B “Average 1” (lower 16 bits)	Float32_t	μg/m ³
50	PM B “Average 1” (upper 16 bits)	Float32_t	μg/m ³
51	PM C “Average 1” (upper 16 bits)	Float32_t	μg/m ³
52	PM C “Average 1” (lower 16 bits)	Float32_t	μg/m ³
53	PM D “Average 1” (lower 16 bits)	Float32_t	μg/m ³
54	PM D “Average 1” (upper 16 bits)	Float32_t	μg/m ³
55	TSP “Average 1” (lower 16 bits)	Float32_t	μg/m ³
56	TSP “Average 1” (upper 16 bits)	Float32_t	μg/m ³
57	PM A “Average 2” (lower 16 bits)	Float32_t	μg/m ³
58	PM A “Average 2” (upper 16 bits)	Float32_t	μg/m ³
59	PM B “Average 2” (lower 16 bits)	Float32_t	μg/m ³
60	PM B “Average 2” (upper 16 bits)	Float32_t	μg/m ³
61	PM C “Average 2” (lower 16 bits)	Float32_t	μg/m ³
62	PM C “Average 2” (upper 16 bits)	Float32_t	μg/m ³
63	PM D “Average 2” (lower 16 bits)	Float32_t	μg/m ³
64	PM D “Average 2” (upper 16 bits)	Float32_t	μg/m ³
65	TSP “Average 2” (lower 16 bits)	Float32_t	μg/m ³
66	TSP “Average 2” (upper 16 bits)	Float32_t	μg/m ³
67	Air XD supply voltage	Uint16_t	mv/bit
68	Laser current / mA	Uint16_t	mv/bit
69	Fan current / mA	Uint16_t	mv/bit
70	Status register	Uint16_t	

12.4 Reading floating point registers

MODBUS itself does not define a floating point data type but it is industry standard to use the IEEE-754 standard for defining floating point numbers. There is, however, there is no clear-cut definition of the byte order of the data payload.

By default, the Trolex Air XD XD uses a little-endian format for the floating point numbers split across two 16-bit MODBUS registers. If this is not compatible with your system and a big endian format or byte swapping is required, the byte ordering can be switched using the on-device menus as shown below.

Main menu

> “Communications” menu > “PM data edianness”

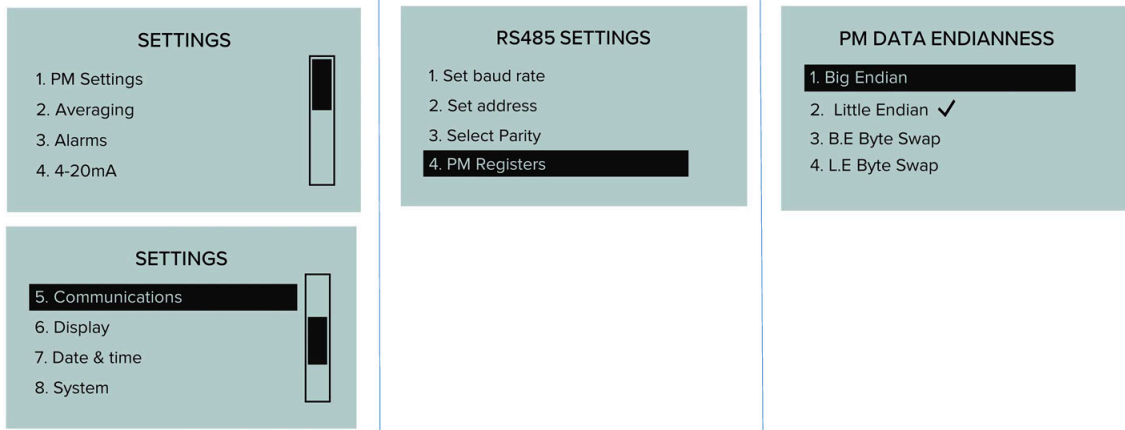

The order of the byte forming the floating-point registers can also be configured remotely through writing to the coil registers.

Coil registers 16 and 17 enact this functionality with the logic table outlined below.

Coil register 16	Coil register 17	Floating point register
0	0	Big endian
0	1	Big endian byte swap
1	0	Little endian
1	1	Little endian byte swap

12.5 Coil register

Function code “1” read.

Function code “5” write.

This is a read/write register containing the instrument binary settings, including alarm status, PM units and 4 - 20 mA output “Enable”/“Disable” status.

Writing to this register will result in the setting being changed permanently. However, if an alarm is activated, writing to the alarm status coil will dismiss the active alarm until the alarm threshold parameters have been re-exceeded.

Register	Description	Data type	Units
0	“Channel 1” alarm status	Bool	
1	“Channel 2” alarm status	Bool	
2	“Channel 1” alarm latch	Bool	1: Latch 0: Auto-reset

3	“Channel 2” alarm latch	Bool	1: Latch 0: Auto-reset
4	“Channel 1” alarm mute	Bool	
5	“Channel 2” alarm mute	Bool	
6	PM units	Bool	0: $\mu\text{g}/\text{m}^3$ 1: mg/m^3
7	Reserved for future use	Bool	0: False 1: True
8	Memory module fitted	Bool	0: Not fitted 1: Fitted
9	4 - 20 mA “Channel 1” “Enable”/“Disable”	Bool	0: Disabled 1: Enabled
10	4 - 20 mA “Channel 2” “Enable”/“Disable”	Bool	0: Disabled 1: Enabled
11	Top cap status (read only)	Bool	0: Open 1: Closed
12	Alarm “Channel 1” “Enable”/“Disable”	Bool	0: Disabled 1: Enabled
13	Alarm “Channel 2” “Enable”/“Disable”	Bool	0: Disabled 1: Enabled
14	Relay 1 override	Bool	0: Relay under alarm control 1: Relay override active
15	Relay 2 override	Bool	0: Relay under alarm control 1: Relay override active
16	Floating point data endianness	Bool	0: Big endian 1: Little endian
17	Floating point data byte swap	Bool	0: No byte swap 1: Byte swapping enabled

12.6 Holding register

Function code “3” read.

Function code “6” write.

This is a read/write register containing the instrument settings and parameters, including instrument date, time, PM assignment and MODBUS settings. Writing to this register will result in the setting being changed permanently.

Note: Writing to the MODBUS settings will result in communication errors until the user has changed their local instrument MODBUS parameters to match the new setting selected on the Air XD.

Register	Description	Data type	Units
0	Time (seconds)	Uint16_t	
1	Time (minutes)	Uint16_t	
2	Time (hours)	Uint16_t	
3	Date (day)	Uint16_t	
4	Date (month)	Uint16_t	
5	Date (year)	Uint16_t	
6	UTC offset (minutes)	Uint16_t	
7	UTC offset (hours)	Uint16_t	
8	PM A assignment	Uint16_t	x 100
9	PM B assignment	Uint16_t	x 100
10	PM C assignment	Uint16_t	x 100
11	PM D assignment	Uint16_t	x 100
12	Alarm 1 assignment	Uint16_t	0 – PM A live 1 – PM B live 2 – PM C live 3 – PM D live 4 – TSP live 5 – PM A Av 1 6 – PM B Av 1 7 – PM C Av 1 8 – PM D Av 1 9 – TSP Av 1 10 – PM A Av 2 11 – PM B Av 2 12 – PM C Av 2 13 – PM D Av 2 14 – TSP Av 2

13	Alarm 2 assignment	Uint16_t	0 – PM A live 1 – PM B live 2 – PM C live 3 – PM D live 4 – TSP live 5 – PM A Av 1 6 – PM B Av 1 7 – PM C Av 1 8 – PM D Av 1 9 – TSP Av 1 10 – PM A Av 2 11 – PM B Av 2 12 – PM C Av 2 13 – PM D Av 2 14 – TSP Av 2
14	Alarm 1 threshold	Uint16_t	As $\mu\text{g}/\text{m}^3$
15	Alarm 2 threshold	Uint16_t	As $\mu\text{g}/\text{m}^3$
16	4 - 20 mA “Channel 1” assignment	Uint16_t	0: PM A 3: PM D
17	4 - 20 mA “Channel 2” assignment	Uint16_t	0: PM A 3: PM D
18	4 - 20 mA “Channel 1” scaling	Uint16_t	
19	4 - 20 mA “Channel 2” scaling	Uint16_t	
20	Average “Channel 1” time	Uint16_t	As minutes
21	Average “Channel 2” time	Uint16_t	As minutes
22	Alarm 2 assignment	Uint16_t	0: 4,800 1: 9,600 2: 14,400 3: 19,200 4: 38,400 5: 57,600 6: 115,200
23	MODBUS address	Uint8_t	

12.7 Instrument self-test

On initial power on, the Air XD is programmed to perform a set of initialisation tests, which are listed and described below. Throughout general function, the Air XD will periodically perform these tests to ensure correct operation.

- **OPC sensor communications check**
Ensures commiunications and correct functionality of the OPC sensor.
- **OPC temperature sensor test**
Ensures the OPC sensor is operating within the specified safe temperature limits.

- **4 - 20 mA self-test**

During instrument start up and initialisation, each 4 - 20 mA output will perform a calibration routine which involves sweeping the output from 0 - 20 mA before returning to 4 mA. After this has been completed, the output will return to configured functionality.

- **Data logging comms test**

Ensures communications and correct functionality of the Air XD memory module.

- **EEPROM memory test**

Ensures communications and functionality of the EEPROM is correct and that custom defined user settings are not lost.

13. UPDATING FIRMWARE

To perform a firmware update, the instrument requires a connection to an external USB drive, formatted to the **FAT32** file system, which has been loaded with the latest firmware release.

Connection to the USB drive is made via the USB interface port located on the underside side of the Air XD as shown in the figure below (remove the IP-rated cover cap to access the USB interface).

Firmware updates should only take place on notification and release from Trolex or an approved distribution partner.

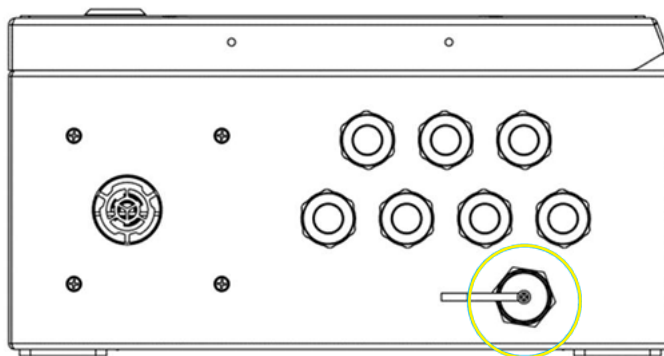

13.1 Units with controller v1.2.3 or earlier and/or memory module v1.4 or earlier

Updating the firmware will result in loss of data download. Ensure that all data is downloaded from the unit before an update is undertaken.

After the memory module has been updated, data logging will only commence after the memory module has been cleared using the on-device menus, the steps for which are outlined in **section 11.46**.

13.2 Preparation

The following steps should be taken prior to updating the instrument:

1. Format a memory stick to **FAT32** file system.
2. Copy the firmware files provided by Trolex or an approved distributor onto the formatted memory stick. The controller files have the format "P5628.704_xx_cont.hex" and the memory module files have the format "P5628.705_xx_mm.hex" (where "xx" is the firmware revision).
3. Insert the USB drive into the Air XD USB interface connector, the display background will turn green on successful pairing with the device.

13.3 Steps to update the controller

1. Navigate to the firmware update menu as shown below and then select the “Controller” on the select device menu.

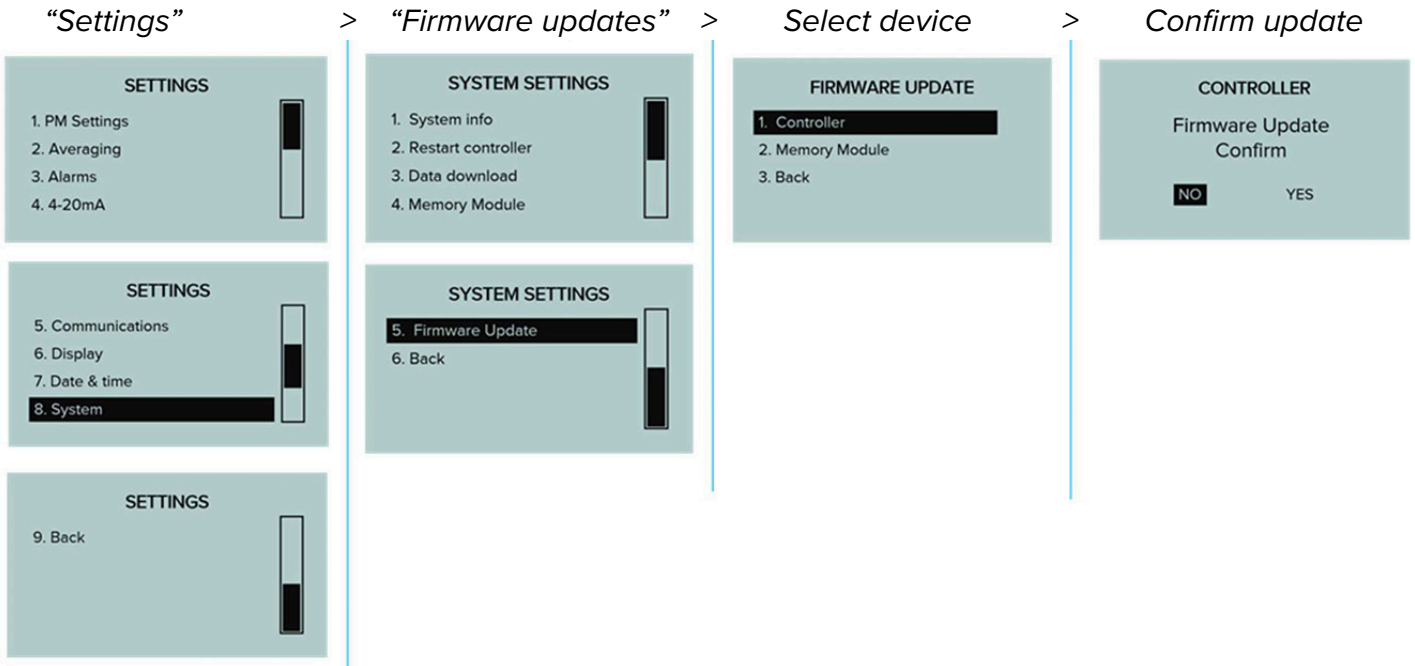

2. Press “YES” to confirm the update, and the controller will then clear the memory in anticipation for the update and a screen will display “Receiving Packet x of x”. Once this is underway, it can take up to 30 minutes to receive all data packets.
3. Once all packets have been received, the unit will restart and perform the update. During this time the screen will go blank for up to 60 seconds. **Do not remove power during this time.**
4. When the update is complete, the unit will reboot, and the new version number will be displayed on the start-up screen and in the “System info” screen.

13.4 Steps to update the memory module

1. Navigate to the firmware update menu as per controller update. Selecting the Memory Module on the select device screen.
2. Press “YES” to confirm the update, the memory module will then begin receiving data from the USB device. The display will show a message reading “Receiving Data...”
3. The firmware update should take no longer than 60 seconds. If the update is a success, a confirmation screen is shown and the user is presented with a “Confirm unit restart” message.
4. Press “Confirm” on unit restart and the instrument will reboot. To view the new memory module firmware version, navigate to the system info screen as shown below.

“Settings”

>

“System settings”

>

“System info”

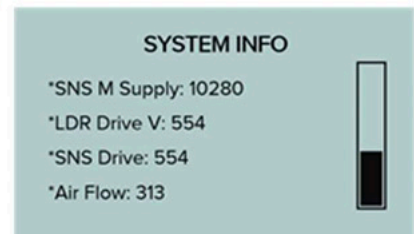
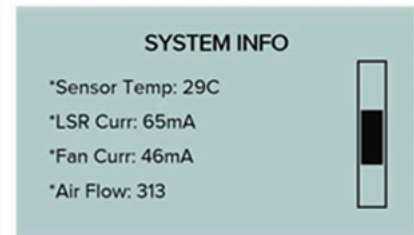
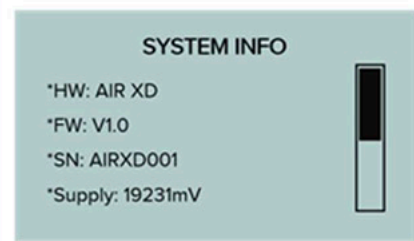
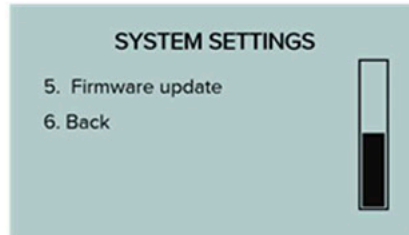
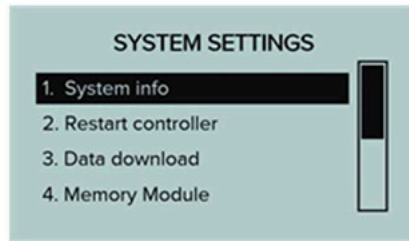
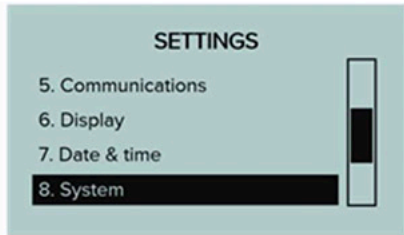

Note: When updating the memory module firmware, all saved data log files will be lost and overwritten. Please ensure all data has been locally downloaded from the unit before proceeding.

After the firmware update, ensure that the ‘Wipe data’ function has been performed before resuming normal operation.

The maintenance of the Air XD must only be carried out by competent personnel. Maintenance should be considered with reference to the local safety regulations, authorities, and guidelines.

14.1 Visual checks

Periodic visual checks should be carried out to assess if there are any issues arising with the Air XD instrument. Check for:

1. External damage to the instrument. Plastic parts should not be cracked or broken, which could affect the IP rating of the instrument.
2. Internal or external damage to wiring that is connected to the Air XD instrument.
3. Labels on the instrument are still in place and are not peeling or discolouring.

14.2 Cleaning labels

It is recommended to periodically clean the instrument with a damp cloth, to ensure the display, keypad and rating labels are clean and legible.

14.3 Air entry/exit apertures

The Air XD has been designed to allow for infrequent pressure washing during maintenance schedules.

Note: Ensure inlet cap is closed before pressure washing the Air XD instrument.

It is important that an appropriate distance is kept between a pressure washer and all Air XD surfaces when cleaning to avoid any damage to the surface being cleaned. Care should also be taken to ensure that the underside of the instrument is not subject to the direct water jet to ensure that water does not enter the air flow path.

The air exit aperture is protected by a stainless steel grille to minimise the ingress of debris into the instrument. It is recommended that the grille is checked and cleaned during maintenance periods.

14.4 Filter replacement

It is recommended that the Air XD is installed with location and proximity consideration to atomising dust suppression systems.

Instrument readings will include atomised or misted sizes that pass through the Air XD sensor, within the particle detection range.

14.5 Preventative maintenance

Dust loading	Average dust loading in mg/m ³	Expected maintenance schedule
Low	Up to 5 mg/m ³	6 to 12 months
Medium	Up to 10 mg/m ³	3 to 6 months
High	10 mg/m ³ or above	1 to 3 months

Particulate types and operating environments vary, therefore the maintenance schedules above should be used as a guide only.

An assessment of site environmental and operating conditions should be carried out periodically to assess the required maintenance.

14.6 Sensor cleaning

As part of the routine maintenance schedule, it is recommended that the sensor is cleaned from time to time following the steps below.

1. Wipe down the Air XD inlet surfaces with a damp cloth in both 'open' and 'closed' positions.
2. Using canned compressed clean air, spray the device inlet for 10 to 15 seconds to clean the dust path.

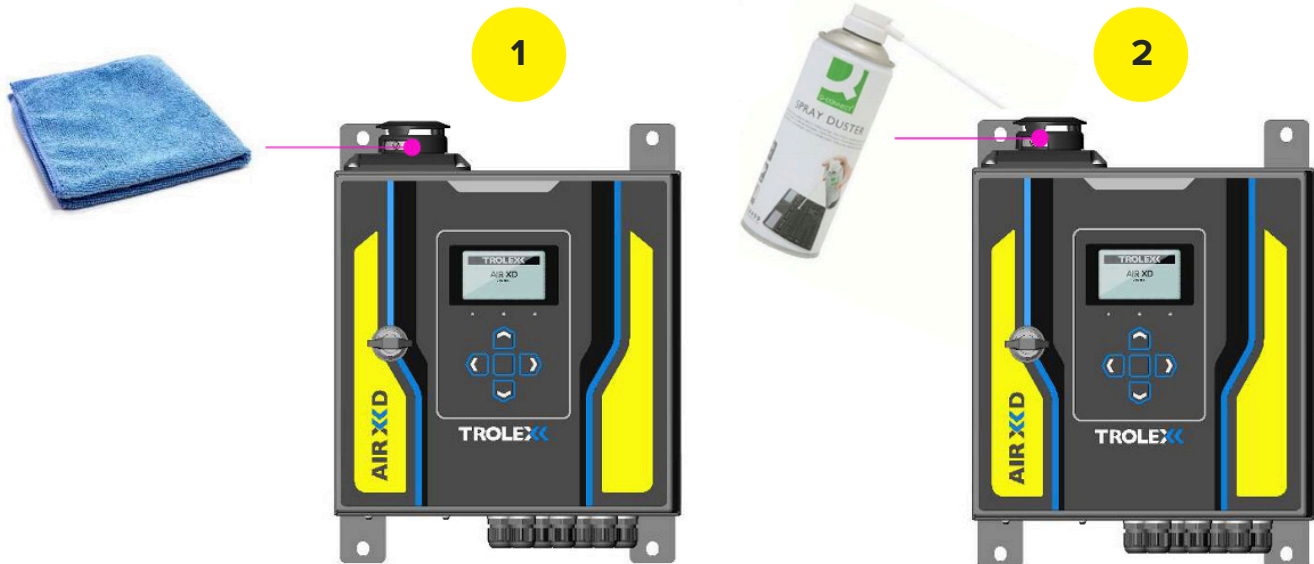

14.7 Compliance audit check

The Air XD has been designed with an inbuilt compliance audit routine/test to allow for the infrequent checking of device functionality against a selection of sized reference particulates.

The on-device compliance audit routine must be carried out using the Trolex Compliance Audit Kit, which contains the accessories required to conduct the procedure, including:

- Particle dispersion hood
- Reference particle sizes (reference material)
- Dosing bottle
- Carry case

The following on-device compliance audit check menu sequence will be presented.

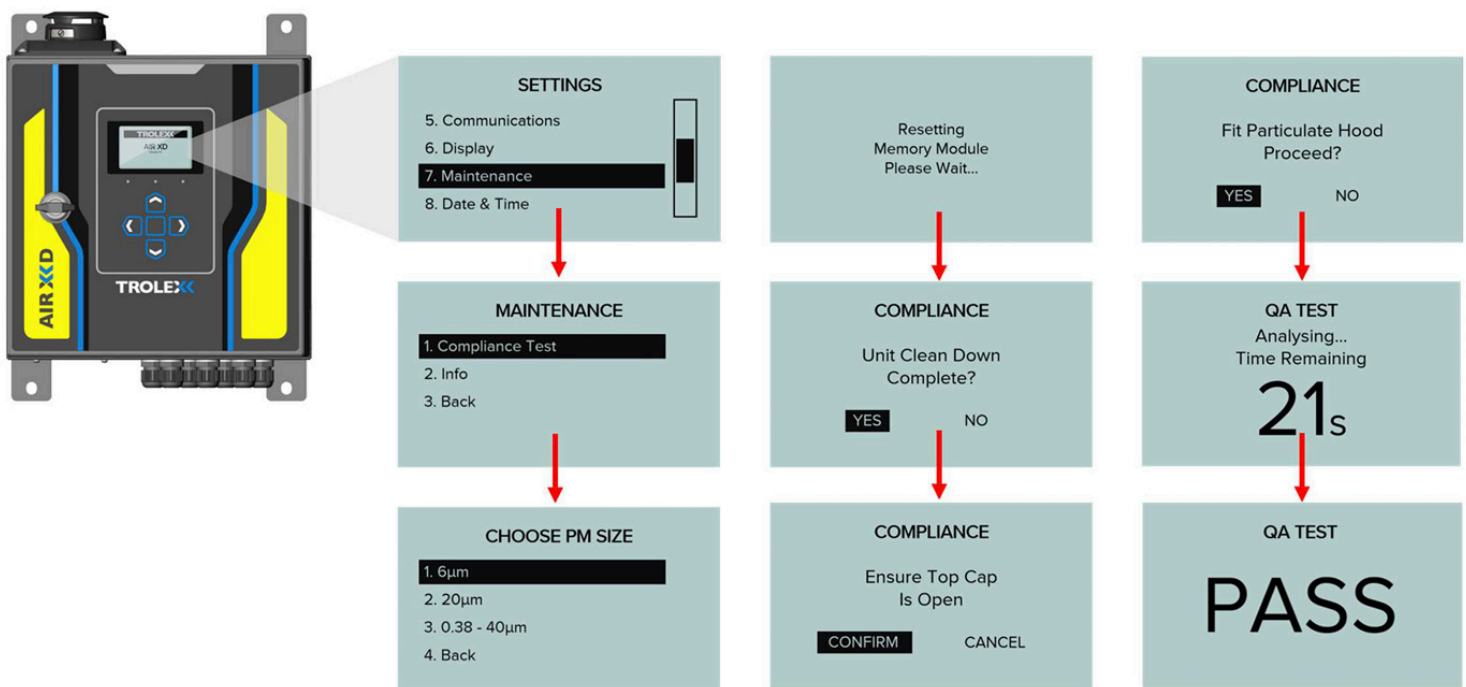

1. “Navigate to the “*Settings*” > “*Maintenance*” > “*Compliance Test*” on the Air XD device.
2. Follow the on-device instructions and select the reference material size required from the “Choose PM Size” menu.
3. The Air XD will reset the memory module in preparation to perform the test. An on-device message will be displayed “Resetting Memory Module - Please Wait...”
4. Following the reset, the Air XD will prompt a clean down. It is important to ensure that the Air XD particulate inlet has been cleaned following the steps outlined in **section 14.5** before selecting “Yes” and proceeding with the test.
5. Ensure that the Air XD top cap is open and select “Yes” to proceed.
6. Once it is confirmed that the top cap is open, the Air XD will prompt the fitting of the particulate dispersion hood that is supplied with the Trolex Compliance Audit Kit. It is important to ensure that the particulate dispersion hood is fitted to the Air XD as shown below and that the dosing opening is accessible.



7. Before selecting “Yes” to continue, ensure that the particulate dosing bottle is filled with the required reference material and ready to be presented to the Air XD.

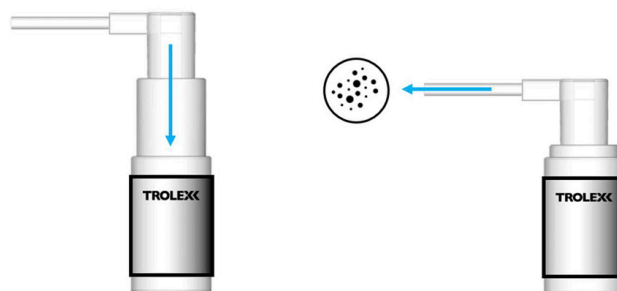

8. “After selecting “Yes” from the “Fit Particulate Hood” screen, use the particulate dosing bottle containing the required size reference material to dose the particulate dispersion hood for the first 10 seconds of the compliance audit check.

Note: It is important to dose the Air XD unit with several measures of the reference particulate material during the first 10 seconds of the compliance audit check.

Dose particulate dispersion hood through entry port.



9. The Air XD will continue to count down and analyse the sample particulate dose for the remain test time frame.
10. On sampling completion, the Air XD will return an on-screen “Pass” or “Fail” result based on the test results and sampled reference particulate. Please see **section 14.7** for detailed test information.
11. On return of a test result, and completion of the compliance audit test, the Air XD will restart the memory module and revert to sampling function/data logging mode.

Note: Users may be required to clean the particle dispersion hood between compliance audit tests.

14.8 Compliance audit check – results

The Air XD is designed to return an on-device “Pass”/“Fail” result based on the compliance audit check results and operational threshold for the applicable particulate sizes.

Return of a “Pass” result

On return of a “Pass” result, the particulate sensor is functioning as expected and normal monitoring operations can resume.

Return of a “Fail” result

Run a sensor cleaning operation as highlighted in **section 14.5**.

1. Repeat the compliance audit check sequence and note the test result.
2. On return of a “Pass” result, the particulate sensor is functioning as expected and normal monitoring operations can resume.

4. On return of a repeat “Fail” result, please contact Trolex to discuss support or servicing options of the Air XD unit.

Device logged test data

As the Air XD test procedure is completed for each particle size, the unit automatically exports specific ‘TRX’ files for the logged test period only. These are saved with a specific file name prefix (‘QA’) to identify them from normal operational data logging file sets, which can be imported into Trolex [Breathe](#) software and analysed as required.

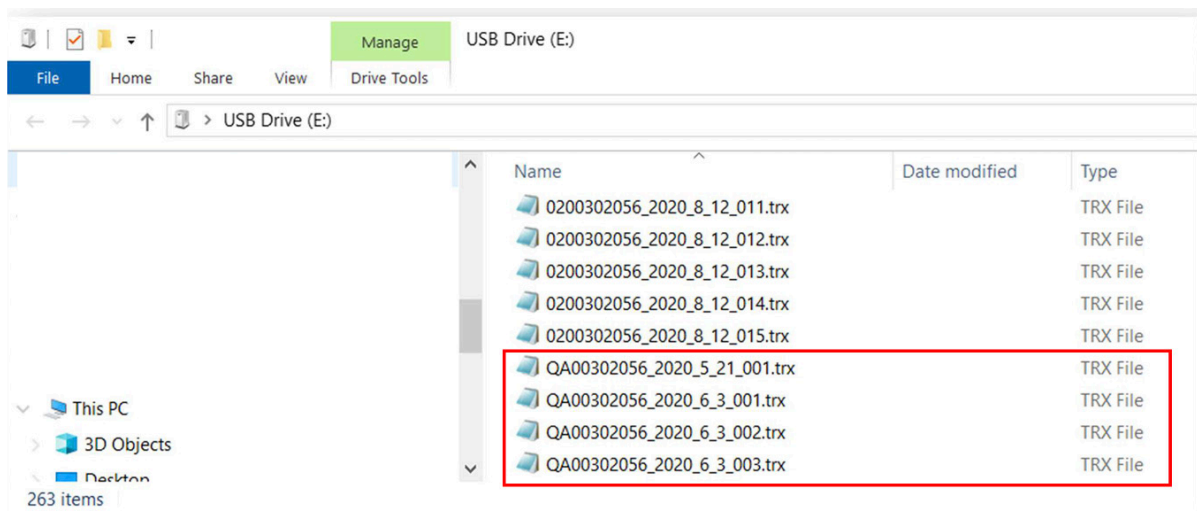

The following sections detail and contain information to assist with the troubleshooting of instrument functionality if required. If an issue is non-resolvable based on the information below, please contact the Trolex product support team.

15.1 High temperature operating

The Air XD operates a protective thermal cut-out sequence when the temperature inside the instrument exceeds the maximum operating temperature specification detailed in **section 7**. This protective measure is in place to maintain the lifespan and operating functionality of the optical sensor assembly when the Air XD is installed in environments with high ambient temperatures.

15.2 Low temperature start-up

If the internal temperature of the instrument is suspected to be below -10°C, for example, if it has been left powered off for a period of time in a very cold environment, damage to the optical assembly may occur when power is applied. Allow the instrument to reach safe operating temperature before applying power.

15.3 Fault codes

The following codes relate to on-screen warnings that the Air XD will display when a fault is encountered during normal operations.

Code	Fault name	Fault description	Fault check
0x0009	Failed to load settings	Failed to load and apply user-configured settings. As standard, the Air XD default settings will be applied.	Re-apply custom settings and check if unit saves and restores files. Contact Trolex or an approved distributor if this fails.
0x0301	No sensor comms	Communications with the particulate sensor assembly has been lost.	Check 'D' type connector to sensor housing and power cycle unit.
0x0304	Fan current too high	Fan may have malfunctioned.	Check instrument is operating within rated temperature range.
0x0305	No fan current	Fan may have malfunctioned.	Check instrument is operating within rated temperature range.
0x0306	Sensor laser current high	Particulate sensor may have failed or is operating at excessive temperatures.	Check instrument is operating within rated temperature range.

0x0307	Sensor laser current low	Particulate sensor may have failed.	Contact Trolex or an approved distributor.
0x0308	Sensor temperature too high	Instrument is operating above specified temperature limits. Instrument has gone in to safe mode.	Reduce operating temperature below 50°C.
0x0402	Lost memory comms	Communications to memory module has failed. Data logging functionality is lost.	Power cycle to reset instrument processor and retry. Contact Trolex or approved distributor if this fails.

16. GLOSSARY AND DEFINITIONS

Air XD_User manual_P5628.1600_Rev E

Flow rate	The volume of air mixture which passes per unit time.
IP	Ingress protection.
TSP	Total suspended particulate matter in the air measuring up to 40 micrometres for standard TSP range and up to 150 micrometres for extended TSP range.
$\mu\text{g}/\text{m}^3$	Microgram per metre cubed. The concentration of an air pollutant given in micrograms (one-millionth of a gram) per cubic metre of air.
mg/m^3	Milligram per metre cubed. The concentration of an air pollutant given in milligrams (one-thousandth of a gram) per cubic metre of air.
OPC	Optical particulate counter.
PPM	Parts per million.
Particulate matter (PM)	General term for a mixture of solids and liquid droplets suspended in the air from typical processes including combustion, industrial activities or natural sources.
PM_x	PM _x is particulate matter x micrometre or less.

17.1 Waste of Electrical and Electronic Equipment (WEEE) Directive (2012/19/EU)



This symbol, if marked on the product or its packaging, indicates that this product must not be disposed of with general household waste.

In the European Union and many other countries, separate collection systems have been set up to handle the recycling of electrical and electronic waste.

At the end of the product's life, do not dispose of any electronic sensor, component or instrument in the domestic waste. Contact Trolex or the distributor for disposal instructions.

18. GET IN TOUCH

18.1 Technical support

Our UK technical services team are available to provide expert ongoing technical assistance and technical support packages tailored to your specific requirements.

Please contact our technical services team:

Telephone: [+44 \(0\)161 483 1435](tel:+44(0)1614831435)

Email: service@trolex.com

18.2 Feedback

If you have any suggestions for improvements or amendments, or find errors in this publication, you can contact marketing@trolex.com directly.

DISCLAIMER

Air XD_User manual_P5628.1600_Rev E

The information provided in this document contains general descriptions and technical characteristics of the performance of the product. It is not intended as a substitute for and is not to be used for determining suitability or reliability of this product for specific user applications. It is the duty of any user or installer to perform the appropriate and complete risk assessment, evaluation and testing of the products with respect to the specific application or use. Trolex shall not be responsible or liable for misuse of the information contained herein. When instruments are used for applications with technical safety requirements, the relevant instructions must be followed.

All pertinent state, regional, and local safety regulations must be observed when installing and using this instrument. For reasons of safety and to help ensure compliance with documented system data, only Trolex or its affiliates should perform repairs to components.

Trolex Ltd. reserves the right to revise and update this documentation from time to time without obligation to provide notification of such revision or change. Revised documentation may be obtainable from Trolex.

Trolex Ltd. reserves the right, without notice, to make changes in equipment design or performance as progress in engineering, manufacturing or technology may warrant.

TRADEMARK

© 2023 Trolex® Ltd.

No part of this document may be reproduced in any form or by any means, electronic or mechanical, including photocopying, without express written permission of Trolex.

Trolex is a registered trademark of Trolex Ltd. The use of all trademarks in this document is acknowledged.

At Trolex, we save lives.

We believe that no person should risk their life to earn a living.

Our aim is to become the world's leading name in health and safety technology, through pioneering products that provide real-world benefits to our customers, whenever workers operate in hazardous environments.

For more information about Trolex, please contact us at:

Enquiries

sales@trolex.com

Telephone

[+44 \(0\) 161 483 1435](tel:+44%201614831435)

Fax

+44 (0) 161 483 5556

Trolex Ltd

[Newby Road, Hazel Grove](#)
[Stockport, Cheshire](#)
[SK7 5DY, United Kingdom](#)

Website

www.trolex.com



[/company/trolexUK](#)



[/trolexUK](#)



[/trolexUK](#)